

MX134 A/V Control Center



Manufactured under license from Dolby Laboratories, “Dolby”, “Pro Logic II”, “Pro Logic” and the double D symbol are registered trademarks of Dolby Laboratories. Surround EX is a jointly developed technology of THX and Dolby Labs, Inc., and is a trademark of Dolby. Used under authorization. Lucasfilm, THX, THX ULTRA, the THX logo, Re Equalization, Re EQ, Timbre Matching, Decorrelation, Bass Management, and Loudspeaker Position Time Synchronization are registered trademarks of Lucasfilm, Ltd and manufactured under license from Lucasfilm Ltd. “DTS”, “DTS ES”, “digital surround”, and “coherent acoustics” are registered trademark of DTS Technology, LLC. and are manufactured under license from DTS Technology LLC.

MX134

The lightning flash with arrowhead, within an equilateral triangle, is intended to alert the user to the presence of uninsulated "dangerous voltage" within the product's enclosure that may be of sufficient magnitude to constitute a risk of electric shock to persons.



AVIS RISQUE DE CHOC ELECTRIQUE - NE PAS OUVRIR.

The exclamation point within an equilateral triangle is intended to alert the user to the presence of important operating and maintenance (servicing) instructions in the literature accompanying the appliance.

WARNING - TO REDUCE RISK OF FIRE OR ELECTRICAL SHOCK, DO NOT EXPOSE THIS EQUIPMENT TO RAIN OR MOISTURE.

NO USER-SERVICEABLE PARTS INSIDE. REFER SERVICING TO QUALIFIED PERSONNEL.

To prevent the risk of electric shock, do not remove cover or back. No user serviceable parts inside.

IMPORTANT SAFETY INSTRUCTIONS!

PLEASE READ THEM BEFORE OPERATING THIS EQUIPMENT.

General:

1. Read these instructions.
2. Keep these instructions.
3. Heed all warnings.
4. Follow all instructions.
5. **Warning: To reduce risk of fire or electrical shock, do not expose this equipment to rain or moisture. This unit is capable of producing high sound pressure levels. Continued exposure to high sound pressure levels can cause permanent hearing impairment or loss. User caution is advised and ear protection is recommended when playing at high volumes.**
6. **Caution: to prevent electrical shock do not use this (polarized) plug with an extension cord, receptacle or other outlet unless the blades can be fully inserted to prevent blade exposure.**
Attention: pour prevenir les chocs electriques pas utiliser cette fiche polarisee avec un prolongateur, une prise de courant ou un autre sortie de courant, sauf si les lames peuvent etre inserees afond ans en laisser aucune partie a decouvert.
7. Unplug this equipment during lightning storms or when unused for long periods of time.
8. Only use attachments/accessories specified by the manufacturer.

Installation:

9. The equipment shall be installed near the AC Socket Outlet and the disconnect device shall be easily accessible.
10. Do not block any ventilation openings. Install in accordance with the manufacturer's instructions.
11. Do not install near any heat sources such as radiators, heat registers, stoves, or other equipment (including amplifiers) that produce heat.
12. Do not use this equipment near water.
13. Do not expose this equipment to dripping or splashing and ensure that no objects filled with liquids, such as vases, are placed on the equipment.
14. Use only with the cart, stand, tripod, bracket, or table specified by the manufacturer, or sold with the equipment. When a cart is used, use caution when moving the cart/equipment combination to avoid injury from tip-over.



Connection:

15. Connect this equipment only to the type of AC power source as marked on the unit.
16. Protect the power cord from being walked on or pinched particularly at plugs, convenience receptacles, and the point where they exit from the equipment.
17. Do not defeat the safety purpose of the polarized or grounding-type plug.

A polarized plug has two blades with one wider than the other. A grounding type plug has two blades and a third grounding prong. The wide blade or the third prong are provided for your safety. If the provided plug does not fit into your outlet, consult an electrician for replacement of the obsolete outlet.

18. Do not overload wall outlets, extension cords or integral convenience receptacles as this can result in a risk of fire or electric shock.
19. To completely disconnect this equipment from the AC Mains, disconnect the power supply cord plug from the AC receptacle.

Outdoor Antenna:

20. If an outdoor antenna is connected to the antenna terminal, be sure the antenna system is grounded to provide some protection against voltage surges and built up static charge. In the U.S.A., section 810 of the National Electrical Code, ANSI/NFPA No. 70-1978, provides information on the proper ground for the mast and supporting structure, ground for the lead-in wire to an antenna discharge unit, and size of ground conductors, location of antenna-discharge unit, connection to ground electrode. For ground wire:
 - A. Use No. 10 AWG (5.3 mm²) copper No. 8 AWG (8.4 mm²) aluminum, No. 17 AWG (1.0 mm²) copper-clad steel, bronze, or larger as ground wire.
 - B. Secure antenna lead-in and ground wires to the house with stand-off insulators spaced from 4 feet (1.2 meters) to 6 feet (1.83 meters) apart.
 - C. Mount antenna discharge unit as closely as possible to where lead-in enters house.

- D. Use jumper wire not smaller than No. 6 AWG (13.3 mm²) copper or equivalent when separate antenna grounding electrode is used.

Care of Equipment:

21. Clean only with a dry cloth.
22. Do not permit objects or liquids of any kind to be pushed, spilled and/or fall into the equipment through enclosure openings.
23. Unplug the power cord from the AC power outlet when left unused for a long period of time.

Repair of Equipment:

24. Refer all servicing to qualified service personnel. Servicing is required when the equipment has been damaged in any way, such as power-supply cord or plug is damaged, liquid has been spilled or objects have fallen into the equipment, the equipment has been exposed to rain or moisture, does not operate normally, or has been dropped.
25. Do not attempt to service beyond that described in the operating instructions. All other service should be referred to qualified service personnel.
26. When replacement parts are required, be sure the service technician has used replacement parts specified by McIntosh or have the same characteristics as the original part. Unauthorized substitutions may result in fire, electric shock, or other hazards.
27. Upon completion of any service or repairs to this product, ask the service technician to perform safety checks to determine that the product is in proper operating condition.

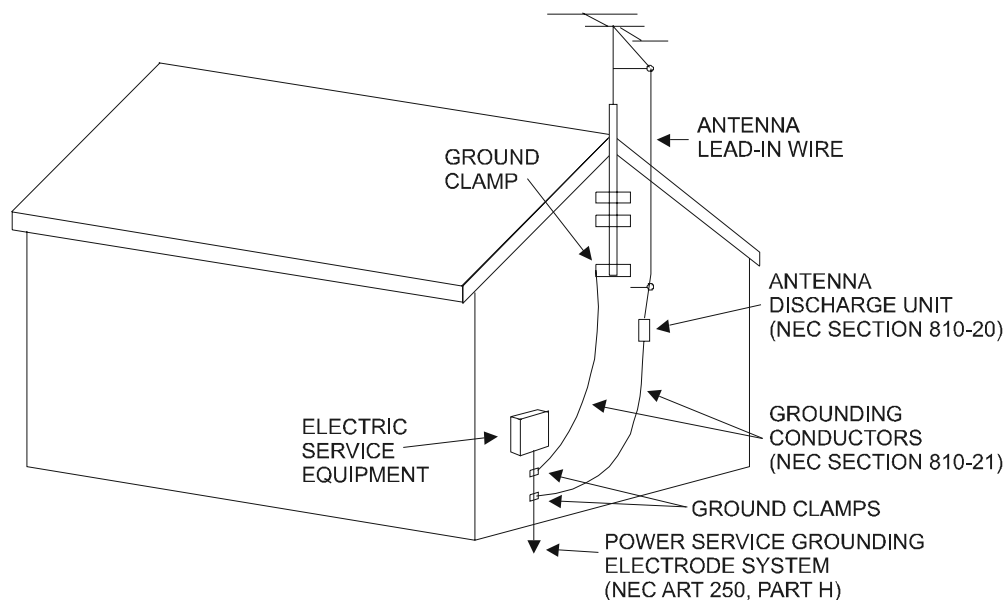

McIntosh

Thank You

Your decision to own this McIntosh MX134 A/V Control Center ranks you at the very top among discriminating music listeners. You now have “The Best.” The McIntosh dedication to “Quality,” is assurance that you will receive many years of musical enjoyment from this unit.

Please take a short time to read the information in this manual. We want you to be as familiar as possible with all the features and functions of your new McIntosh.

Please Take A Moment

The serial number, purchase date and McIntosh Dealer name are important to you for possible insurance claim or future service. The spaces below have been provided for you to record that information:

Serial Number: _____

Purchase Date: _____

Dealer Name: _____

Technical Assistance

If at any time you have questions about your McIntosh product, contact your McIntosh Dealer who is familiar with your McIntosh equipment and any other brands that may be part of your system. If you or your dealer wish additional help concerning a suspected problem, you can receive technical assistance for all McIntosh products at:

McIntosh Laboratory, Inc.
2 Chambers Street
Binghamton, New York 13903
Phone: 607-723-1545
Fax: 607-723-3636

Customer Service

If it is determined that your McIntosh product is in need of repair, you can return it to your Dealer. You can also return it to the McIntosh Laboratory Service Department. For assistance on factory repair return procedure, contact the McIntosh Service Department at:

McIntosh Laboratory, Inc.
2 Chambers Street
Binghamton, New York 13903
Phone: 607-723-3515
Fax: 607-723-1917

Table of Contents

Safety Instructions	2
Thank You	4
Please Take a Moment	4
Technical Assistance	4
Customer Service	4
Table of Contents	4
General Notes	5
Connector Information	6
Introduction	7
Performance Features	7
Dimensions	8
Installation	9
Connections	
Rear Panel Multizone, Control and Switch	10
Rear Panel Audio and Digital Connections	11
Rear Panel Video Connections	12
How to Connect Multizone and Control	13
How to Connect Audio and Digital Components	14
How to Connect Video Components	15
How to Connect for Zone B	16
Front Panel Features	
Front Panel Controls and Sensor	17
Front Panel Push-buttons and Switch	18
Front Panel Displays	19
Remote Control	
Remote Control Push-buttons	20
How to Operate by Remote Control	21
Setup Mode	
How to Operate the Setup Mode	22
Default Settings	23
How to Adjust for Loudspeaker Size	25
How to Adjust Loudspeaker Time Delay	27
How to Adjust Loudspeaker Levels	28
How to Change the Input Setup	30
How to Change the Surround Mode Setup	36
How to Adjust Zone B Setup	37
How to Change the Advanced Settings	38
Operation	
How to Operate the MX134	41
How to Operate the Trim Mode	44
How to Operate the Surround Mode	46
How to Make a Tape Recording	48
How to Operate Zone B	48
Additional Information	
Audio and General Specifications	50
TM1 AM/FM Tuner Module	
TM1 Table of Contents	52
Packing Instructions	59

General Notes

1. The MX134 A/V Control Center has provisions for adding an optional McIntosh TMI AM/FM Tuner Module for Radio Station Reception. The TMI is available from your McIntosh Dealer and can be installed at any time, usually while you wait. Refer to page 52 for additional TMI information.
2. The Main AC Power going to the MX134 and any other McIntosh Component(s) should not be applied until all the system components are connected together. Failure to do so could result in malfunctioning of some or all of the system's normal operations. When the MX134 and other McIntosh Components are in their Standby Power Off Mode, the Microprocessor's Circuitry inside each component is active and communication is occurring between them.
3. Connecting Cables and Connectors are available from the McIntosh Parts Department:
 - Data and Power Control Cable Part No. 170-202**
Six foot, shielded 2 conductor, with 1/8 inch stereo mini phone plugs on each end.
 - Control Center to Multi-Channel Power Amplifier Cable Part No. 170-631**
Six foot, DB25, shielded, straight through, 25 conductor male to female cable.
 - Control Center to CR16 Cable Part No. 170-430**
Six foot, DB37, shielded, straight through, 37 conductor male to male cable.
4. For additional connection information, refer to the owner's manual(s) for any component(s) connected to the MX134 A/V Control Center.
5. When the MX134 is connected to a McIntosh MC206 Power Amplifier with a 25 conductor cable, the amplifier meters will automatically indicate the output of each individual channel during the Speaker Level Setup Operation. This meter function is independent of any Meter Mode selections on the MC206 front panel.
6. When the MX134 is connected to a CR16 Controller Input B jack with the 37 conductor cable, do not connect a 25 conductor cable to the CR16 Controller Input A jack from another McIntosh Control Center.
7. System Setup operations must be performed in the order they appear in the Main System Setup Menu as they are interactive.
8. The Zone A and Zone B IR Inputs, with 1/8 inch mini phone jacks, are configured for non McIntosh IR sensors such as a Xantech Model 291 10. To avoid possible interaction, disable the MX134 Front Panel Sensor with the switch recessed in the bottom panel behind the Setup Push button.
9. In order to hear bass frequencies below 80Hz, your system must include either a Subwoofer or Large Front Loudspeakers.
10. Zone B Audio is analog only, a Digital Audio Input Signal Source will not appear at the Zone B Audio Outputs. The source component Analog Outputs must also be connected to the MX134.
11. When an assigned Digital Input and a matching Analog Input are in use, the MX134 automatically searches first for

- a Digital Signal. If no Digital Signal is sensed, it switches to the Analog Input.
12. Certain DVD or Laser Video Disc Players that are reproducing Digital DTS Signals into a MX134 Digital Input, may only produce noise from their Analog Outputs. If Zone B is turned on and that same input is selected, that noise will be heard.
 13. When the MX134 is connected with a CR16, the MX134 provides fixed specific audio signals that match the CR16 Inputs. If the MX134 Inputs listed below are re titled, the Inputs Titles on the CR16 will no longer match. For example, if the MX134 TV Input (7), is reassigned as DVD2, selecting the TV Input on the CR16 will receive the audio signals from DVD2.
- | <u>MX134 Inputs</u> | <u>CR16 Inputs</u> | <u>MX134 Inputs</u> | <u>CR16 Inputs</u> |
|---------------------|--------------------|---------------------|--------------------|
| 0. TUNER | → TUNER | 7. TV | → TV |
| 1. AUX | → AUX | 8. LV | → LV |
| 3. CD2 | → CD2 | 9. VCR1 | → VCR1 |
| 4. TAPE 1 | → TAPE 1 | 11. DVD | → DVD |
14. The MX134 Input Source Name "DVD" is equivalent to "V Aux" on some McIntosh Keypads, Remote Controls and Audio/Video Control Centers.
 15. Up to four McIntosh Sensors or Keypads can be wired in parallel for both Zones A and B.
 16. When a McIntosh WK 2 Keypad or an R649 Sensor is to be connected to the McIntosh MX134 A/V Control Center that uses a RJ 45 Connector Plug instead of the "F" Coax Connector, connect the Center Conductor to Pin 1 and the Shield Conductor to Pin 2. Refer to the figure below.

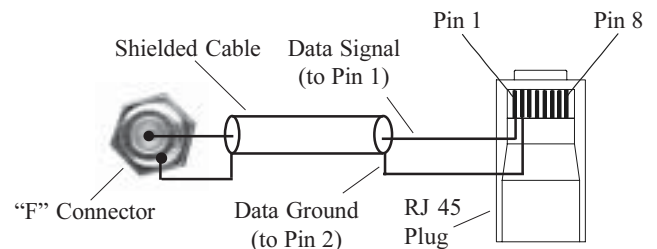

17. There are three types of Video Signals that can be connected to and selected by the MX134; Composite, S Video and Component. Zone A and B, VCR 1 and 2 have both Composite and S Video Outputs; the Component Video Output is for Zone A only. The MX134 has Digital Video Processing Circuitry that will Up Convert the desired Composite Input to S Video; it will also Up Convert the desired Composite and/or S Video Inputs to Component Video.

Connector Information

Keypad Terminal Connector

To use a WK-3 or WK-4 Keypad with the MX134, connect the shield and four leads of a shielded 4 conductor cable to a RJ-45 Connector Plug, according to the numbers listed below. There is a numbered connector built-in to each Keypad, which has a different pin out.

MX134 RJ-45

1. Signal Data
2. Signal Data Gnd. and Cable Shield
3. N/C
4. Supply Voltage Negative
5. Supply Voltage Positive
6. N/C
7. N/C
8. N/C

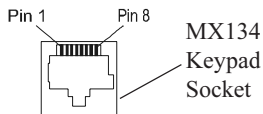

WK-3 and WK-4 Keypad

1. Supply Voltage Positive
2. Supply Voltage Negative
3. Cable Shield
4. Signal Data
5. Signal Data Gnd.

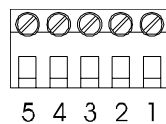

RS232 DB9 Connector Pin Layout

1. N/C
2. Data Out (TXD)
3. Data In (RXD)
4. N/C
5. Gnd.
6. N/C
7. N/C
8. N/C
9. N/C

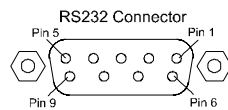

Multi-Channel Amp DB25 Connector Pin Layout

1. Left Front +
2. Center Front +
3. Right Front +
4. N/C
5. Left Surround +
6. Right Surround +
7. Left Back Surround +
8. Right Back Surround +
9. N/C
10. N/C
11. N/C.
12. System Calibrate
13. Power Control In
14. Left Front Gnd.
15. Center Front Gnd.
16. Right Front Gnd.
17. N/C
18. Left Surround Gnd.
19. Right Surround Gnd.
20. Left Back Surround Gnd.
21. Right Back Surround Gnd.
22. N/C
23. N/C
24. System Calibrate Gnd.
25. Power Control Gnd.

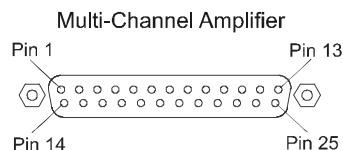

Multizone Controller (DB37 Connector):

- | | | |
|-----------------|-----------------|------------------|
| 1. Accessory-On | 14. LV-Left | 26. CD-Data |
| 2. SYS-Off | 15. TV-Left | 27. N/C |
| 3. Sum Data | 16. Aux-Left | 28. N/C |
| 4. DVD-Data | 17. Tape 1-Left | 29. Ground |
| 5. LV-Data | 18. Tuner-Left | 30. DVD-Right |
| 6. Aux-Data | 19. CD-Left | 31. VCR 1-Right |
| 7. Tuner-Data | 20. Video Power | 32. LV-Right |
| 8. N/C | 21. Ground | 33. TV-Right |
| 9. N/C | 22. Home-Data | 34. Aux-Right |
| 10. N/C | 23. VCR 1-Data | 35. Tape 1-Right |
| 11. Ground | 24. TV-Data | 36. Tuner-Right |
| 12. DVD-Left | 25. Tape 1-Data | 37. CD-Right |

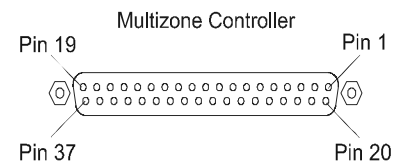

Power Control Connector

The MX134's Power Control Outputs provide a 5 volt signal. Use a 1/8 inch stereo mini phone plug to connect to the Power Control Input on other McIntosh Components.

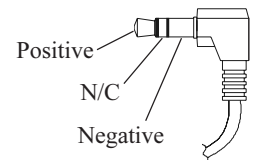

Data and IR Input Port Connectors

The MX134's Data Port Output provides Remote Control Signals. Use a 1/8 inch stereo mini phone plug to connect to the Data Port Inputs on McIntosh Source Units. The IR Ports also use a 1/8 inch stereo mini phone plug and allows the connection of other brands IR Sensors to the MX134.

Note: The MX134 Rear Panel IR POWER Switch setting determines if twelve volts are present at the Zone A and B IR INPUTS.

IR Input Port Connector with Rear Panel IR Power Switch Set to Off

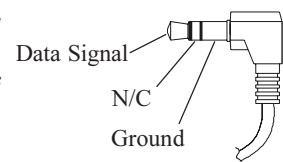

IR Input Port Connector with Rear Panel IR Power Switch Set to On

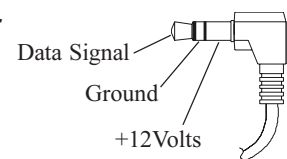

Introduction

Now you can take advantage of traditional McIntosh standards of excellence in the MX134 A/V Control Center as the heart of your Home Theater System. The MX134 provides superior seven channel reproduction, Dolby Digital, THX Surround EX and DTS ES decoding combined with complete audio and video switching. The McIntosh MX134 sets new standards for accuracy in a Home Theater System.

Performance Features

- **On Screen and Multifunction Fluorescent Displays**

A comprehensive On-Screen Display capability makes it easy to perform setup adjustments using the MX134 Remote Control. The front panel display indicates volume levels, tuner functions, input selection, operating mode and setup functions.

- **Automatic Mode Switching with Auto Memory**

The MX134 Automatically Switches Operating Modes according to the input signal. Zone A will memorize the Preferred Mode settings last used for each input. When switching from one input to another, the selected mode for each will be active.

- **Separate Listen and Record Input Selection**

The 11 Analog A/V and 6 Digital Audio Inputs can be re-assigned for any desired signal sources. Any unused input can be “turned off” so the input selector will skip over it. All six digital inputs can be assigned to any A/V signal source for Zone A. Separate Record and Listen Circuits allow recording of one program source while listening to another.

- **LED Channel Status Indicators**

The MX134 includes thirteen LEDs on the front panel to indicate what type of operating signals are being received and the output format chosen.

- **Pure Stereo Outputs**

When Stereo Operation is selected for an analog source, pure, unprocessed stereo signals appear at the left and right front outputs.

- **Adjustable Channel Level and Time Delay**

A built-in test signal generator allows all eight channels to be calibrated for precise volume levels with either automatic or manual channel switching and can be adjusted for time delay to compensate for different distances from each Loudspeaker to the listening area.

- **Digitally Controlled Volume and Tone Controls**

A Precision Tracking Volume Control adjusts all eight channels with tracking accuracy better than 0.5dB. Digitally controlled bass, treble and loudness analog circuits provide a wide range of tone shaping with no loss in traditional McIntosh sonic excellence.

- **Video Switching with Digital Video Processing**

Any Composite and/or S-Video Input can be Up-Converted to a Component Video Signal with the built-in Digital Video Processing Circuitry. There is also video switching for all three types of video signals.

- **External Eight Channel Input**

An external eight channel signal processor can be connected to these inputs as well as a DVD-Audio Player or Super Audio Disc Players with a built-in processor.

- **THX® Signal Processing**

The THX CINEMA SURROUND mode with THX Signal processing present, will provide the best possible reproduction of a film sound track that was originally created for use in a movie theater. THX Re-Equalization™ and Timbre Matching™ takes the edginess or “brightness” out of your Movie Sound Tracks and matches the tone of your Front Loudspeakers to your surrounds. Adaptive Decorrelation™ gives a stereo “feel” when your Surrounds are playing mono and automatically switches off when they are playing stereo. Bass Management™ Electronic Crossover allows you to use more compact Loudspeakers, while sending bass to a Subwoofer System. Loudspeaker Position Time Synchronization™ lets you easily set up your Home Theater System for an optimum listening position.

- **Dual Zone and Additional Expansion**

The MX134 has the built-in ability to control a separate remote audio/video zone with its own dedicated power amplifier and speakers. Zone B program selection is independent of the Zone A selected program. A rear panel connector is provided to interface with the CR16 Remote Control System to add four additional Remote A/V Zones.

- **Special Power Supply**

Fully regulated power supply with double shielded power transformer ensures stable noise free operation even if the power line should vary.

Dimensions

The following dimensions can assist in determining the best location for your MX134. There is additional information on the next page pertaining to installing the MX134 into cabinets.

Front View of the MX134



Rear View of the MX134

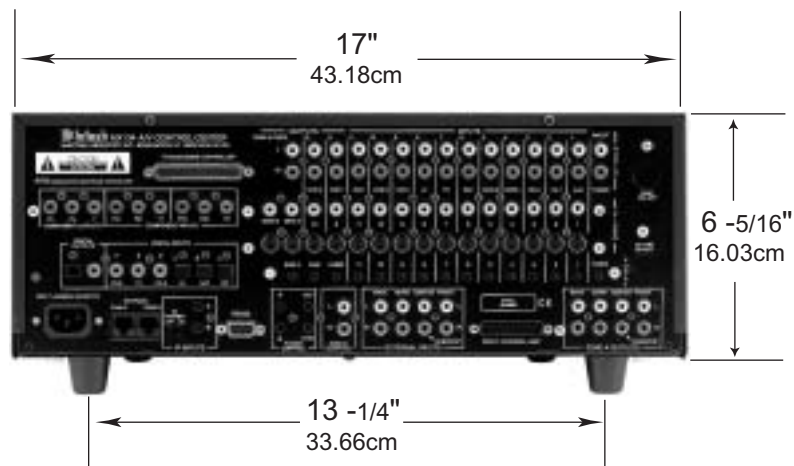

Side View of the MX134

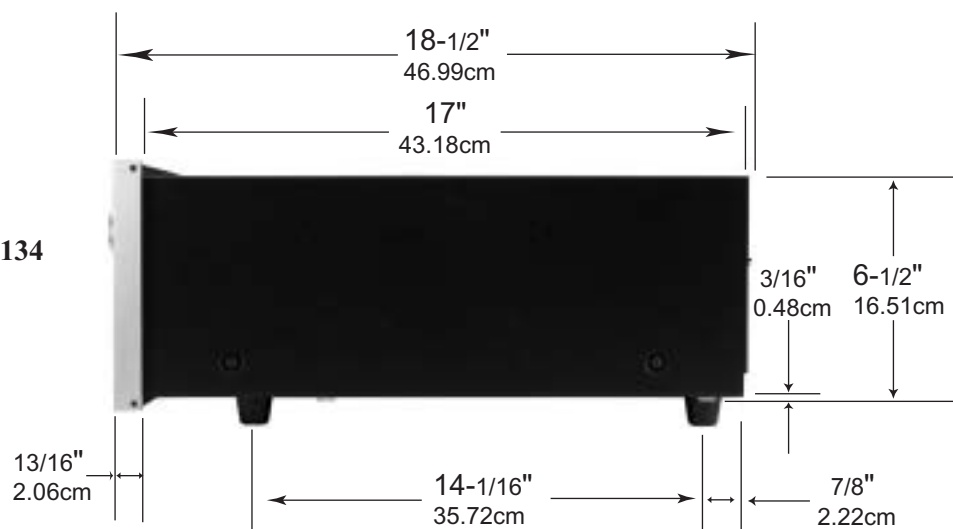

Installation

The MX134 can be placed upright on a table or shelf, standing on its four feet. It also can be custom installed in a piece of furniture or cabinet of your choice. The four feet may be removed from the bottom of the MX134 when it is custom installed as outlined below. The four feet together with the mounting screws should be retained for possible future use if the MX134 is removed from the custom installation and used free standing. The required panel cutout, ventilation cutout and unit dimensions are shown.

Always provide adequate ventilation for your MX134. Cool operation ensures the longest possible operating life for any electronic instrument. Do not install the MX134 directly above a heat generating component such as a high powered amplifier. If all the components are installed in a single cabinet, a quiet running ventilation fan can be a definite asset in maintaining all the system components at the coolest possible operating temperature.

A custom cabinet installation should provide the following minimum spacing dimensions for cool operation. Allow at least 2 inches (5.08cm) above the top, 2 inches (5.08cm) below the bottom and 1 inch (2.54cm) on each

side of the A/V Control Center, so that airflow is not obstructed. Allow 21 inches (53.34cm) depth behind the front panel. Allow 1-1/8 inch (2.9cm) in front of the mounting panel for knob clearance. Be sure to cut out a ventilation hole in the mounting shelf according to the dimensions in the drawing.

MX134 Front Panel Custom Cabinet Cutout

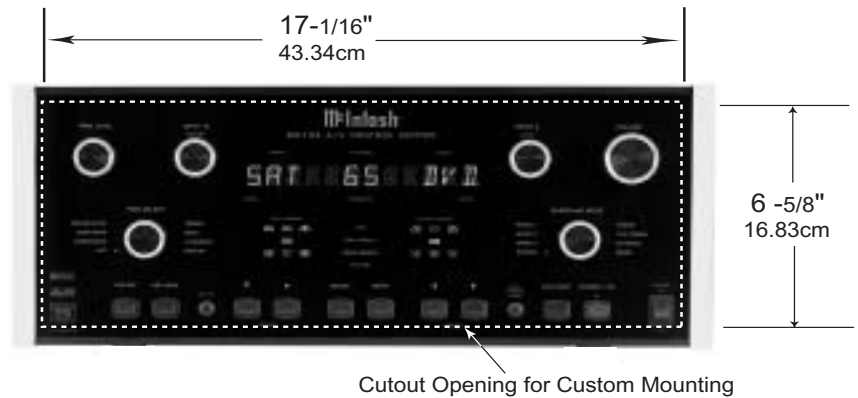

MX134 Side View in Custom Cabinet

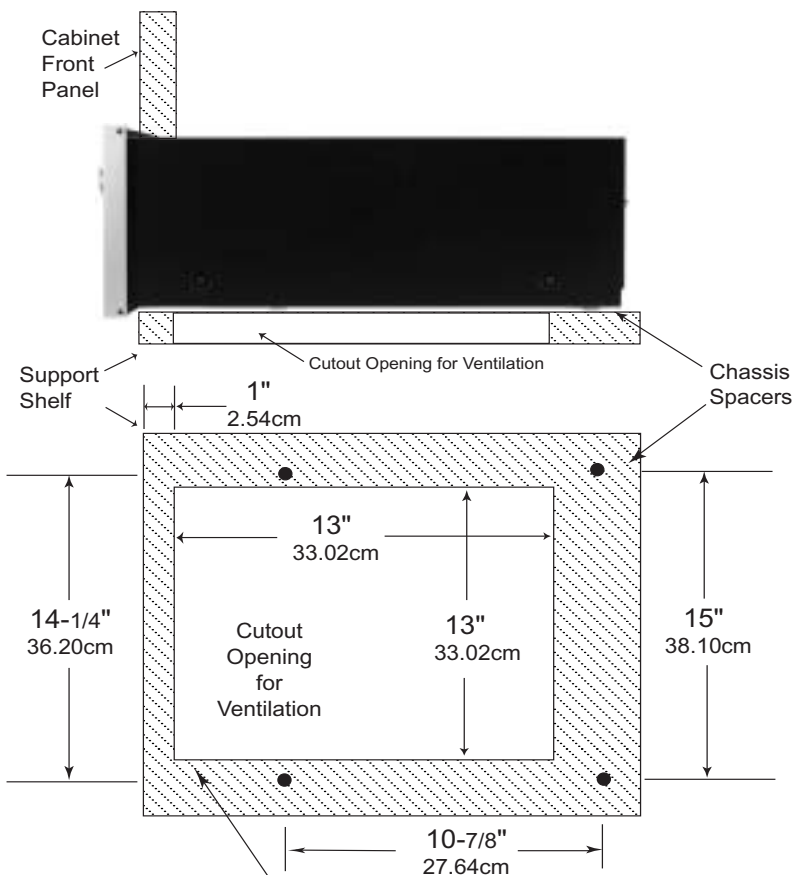

MX134 Bottom View in Custom Cabinet

Notes: Center the Cutout Horizontally on unit. For purposes of clarity, the above illustration is not drawn to scale.

TO MULTIZONE CONTROLLER connects to the McIntosh Multizone Controller Input B

SUM A Data Port for connections to the other McIntosh Components

HOME Data Port connects to the optional HC-1 Home Controller

IR POWER On/Off for Zone A or B external Sensors

RS232 connector for connection to a computer or other control device

SUM Data Port for Zones A and B provides connections to the other McIntosh Components

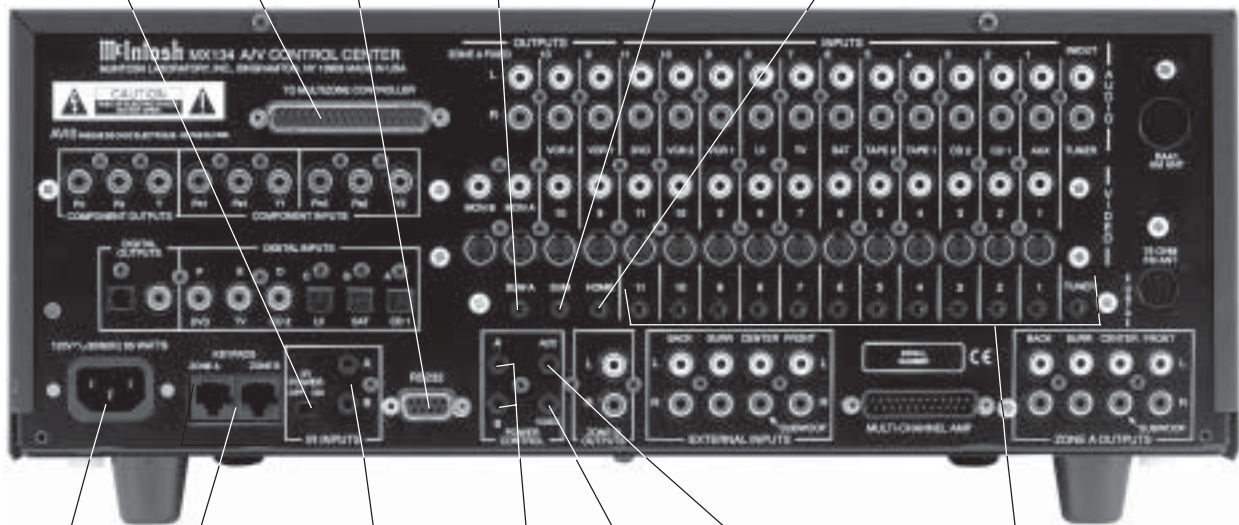

KEYPADS ZONE A and B for a McIntosh Keypad or IR room sensor

POWER CONTROL A and B send a turn On/Off signals to a McIntosh Power Amplifier for each Area

ACC sends a turn On/Off signals to McIntosh Source Components

Connect the MX134 power cord to a live AC outlet. Refer to information on the back panel to determine the correct voltage

IR INPUTS for Zone A or B external Sensors

VIDEO sends a turn On/Off signals to McIntosh Video Source Components

DATA Ports send signals to compatible source components to allow remote control operation

DIGITAL INPUTS CD2, TV and DVD receive a digital audio signal from the Coaxial Output of a component

ZONE A FIXED OUTPUTS send a fixed line level, two channel analog signal as selected by the INPUT A control

INPUTS for analog audio signals from a DVD, LV, VCR, TV, SAT, CD, TAPE or AUX components

DIGITAL INPUTS CD1, SAT, and LV receive a digital audio signal from the Optical Output of a component

OUTPUTS VCR 1 and 2 supply analog audio record signals for recorders

TUNER INPUT/OUTPUT allows for connecting an external tuner to the MX134 when the optional TM1 Module is not installed inside or Tuner Audio Output Signals when the TM1 is installed inside the MX134

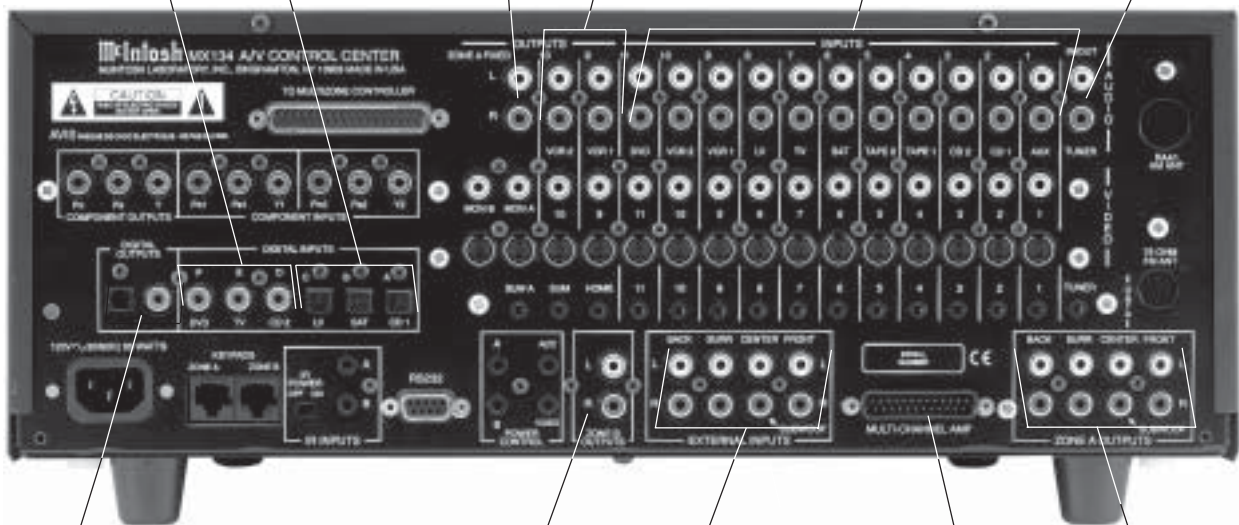

DIGITAL OUTPUTS both optical and coaxial, provide a digital audio signal to an external digital processor

The eight channel EXTERNAL INPUTS accept audio signals from a component or external processor

ZONE A OUTPUTS send all eight audio channel signals to power amplifier inputs

ZONE B OUTPUTS send a two channel signal from the analog inputs as selected by the INPUT B Control

MULTI-CHANNEL AMPLIFIER connector accepts a 25 conductor cable that connects all audio and power control signals to a McIntosh Power Amplifier

COMPONENT INPUTS receive Component Video (Y, P_R and P_B) Signals from two Component Video Sources

OUTPUTS for VCR 1 and 2 supply Composite Video Signals for recorders

Note: If the MX134 A/V System Control Center has the TMI AM/FM Tuner Module installed, proceed to page 53 for Rear Panel Antenna Connection Information.

OUTPUT MONitor A sends a Composite or S-Video Signal to a monitor/TV located in Zone A

INPUTS for Composite Video Signals from a DVD, LV, VCR, TV, SAT, CD, TAPE or AUX components

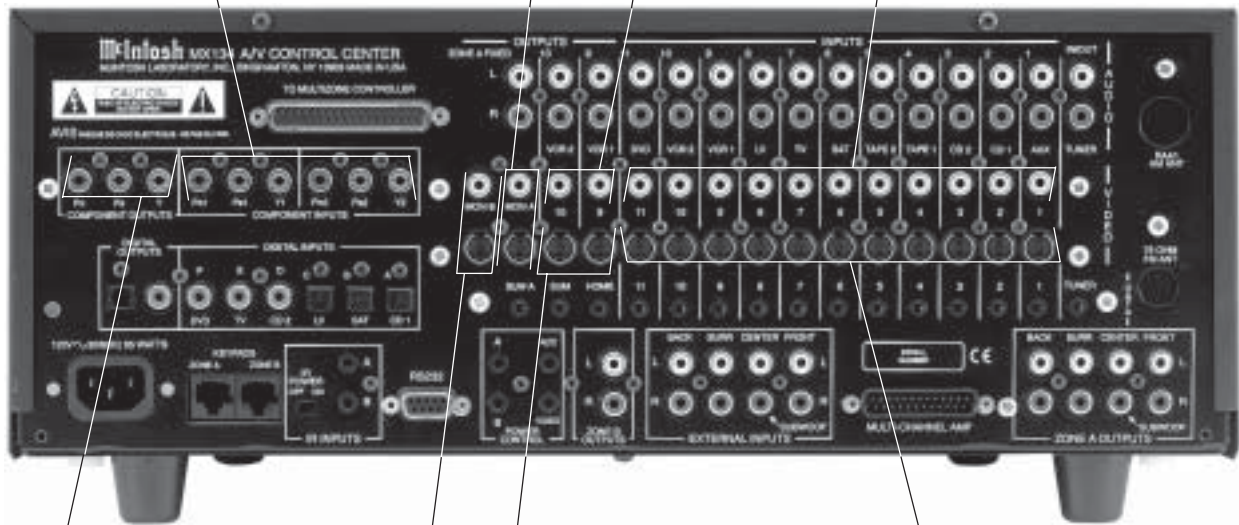

OUTPUT MONitor B sends a Composite or S-Video Signal to a monitor/TV located in Zone B

INPUTS for S-Video Signals from a DVD, LV, VCR, TV, SAT, CD, TAPE or AUX components

COMPONENT OUTPUTS send Component Video (Y, P_R and P_B) Signals to the ZONE A Video Monitor

OUTPUTS for VCR 1 and 2 supply S-Video Signals for recorders

How to Connect Multizone and Control

1. Connect a Data Control Cable from the MX134 DVD (input 11) Data Port to the McIntosh MVP841 DVD Player Data In Jack.
Note: By adding a McIntosh Remote Control Translator to the MX134, non McIntosh Source Devices such as a Satellite Receiver can be remotely controlled using a McIntosh Remote Control and Keypads.
2. Connect a Data Control Cable from the MX134 HOME Data Port to the Home Controller Data In Jack.
3. Connect a 4 conductor shielded cable from the MX134 ZONE A KEYPAD Socket to a McIntosh WK-4 Keypad.
4. Connect a DB37 Cable, shielded straight through 37 conductor, from the MX134 TO MULTIZONE CON-

5. TROLLER Connector to the CR16 Multizone “Controller Input B” socket.
6. Connect a Power Control Cable from the MX134 POWER CONTROL A Jack to the McIntosh MVP841 DVD Player Power Control In Jack.
7. Connect a Power Control Cable from the McIntosh MVP841 DVD Player Power Control Out Jack to the McIntosh Powered Subwoofer Power Control In Jack.
8. Connect a Power Control Cable from the McIntosh MVP841 DVD Player Power Control Out Jack to the McIntosh Powered Subwoofer Power Control In Jack.
9. Connect a Power Control Cable from the McIntosh MVP841 DVD Player Power Control Out Jack to the McIntosh PC-4 Power Control AC Outlet Strip Power Control Jack.
10. Optionally, connect a Data Control Cable from the MX134 IR INPUTS A to an external IR Sensor.

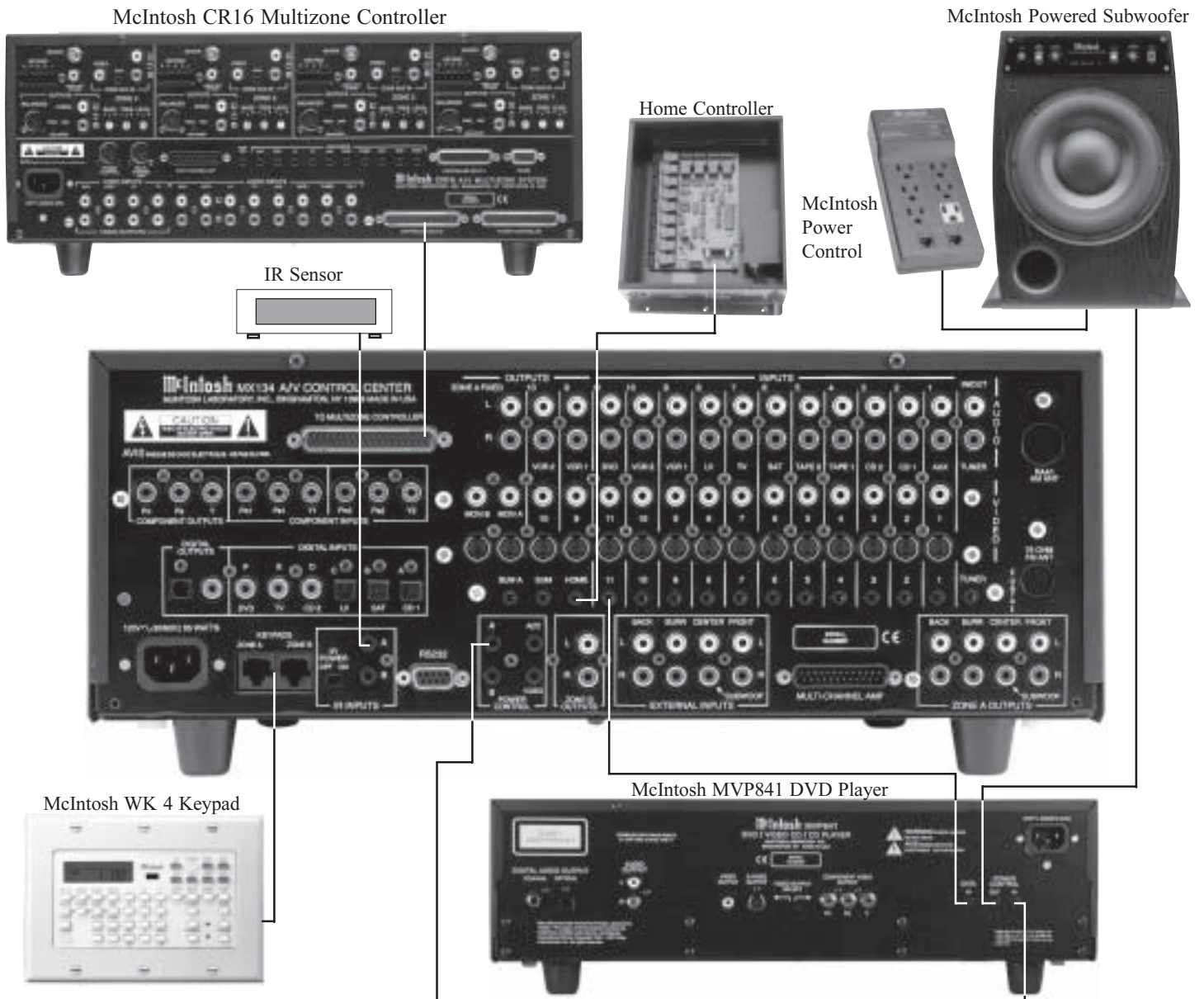

How to Connect Audio and Digital Components

The MX134 accepts Analog Audio and Digital Audio Signal Inputs. It is important to connect the Analog Outputs along with the Digital Audio Signal Output from source components connected to the MX134. This will assure that the audio from that source component is available to the VCR1 and 2 Outputs, Zone B and optional CR16 Multizone System.

1. Connect a DB25 Cable, shielded straight through 25 conductor, from the MX134 MULTI-CHANNEL AMP Connector to the McIntosh Six Channel Power Amplifier Multi-Channel Input Socket.
2. Connect a cable from the MX134 DIGITAL CO-AXIAL DVD INPUT (Input F) to the McIntosh Co-axial Digital Output of the MVP841 DVD Player.
3. Connect a cable from the MX134 Analog Audio INPUTs (Input 11) to the McIntosh Audio Outputs of the MVP841 DVD Player.
4. Connect a cable from the MX134 SAT INPUT (Input B) OPTICAL DIGITAL INPUT to the Optical Digital Output of a Satellite Receiver.
5. Connect a cable from the MX134 Left and Right Analog Audio INPUTs (Input 6) to the Left and Right Analog Audio Outputs of the Satellite Receiver.

6. Connect a cable from the MX134 VCR1 Audio OUTPUT (Output 9) to the VCR Audio Input.
7. Connect a cable from the MX134 VCR1 Audio INPUT (Input 9) to the VCR Audio Output.
8. Connect a cable from the MX134 CD1 INPUT (Input A) OPTICAL DIGITAL INPUT to the Optical Digital Output of the DVD-Audio/SACD Disc Player.
9. Connect cables from the MX134 EXTERNAL Audio INPUTs to the DVD-Audio/SACD Disc Player Audio Outputs.
10. Connect a cable from the MX134 ZONE A SUBWOOFER OUTPUTS to the McIntosh Powered Subwoofer Line In Jack.

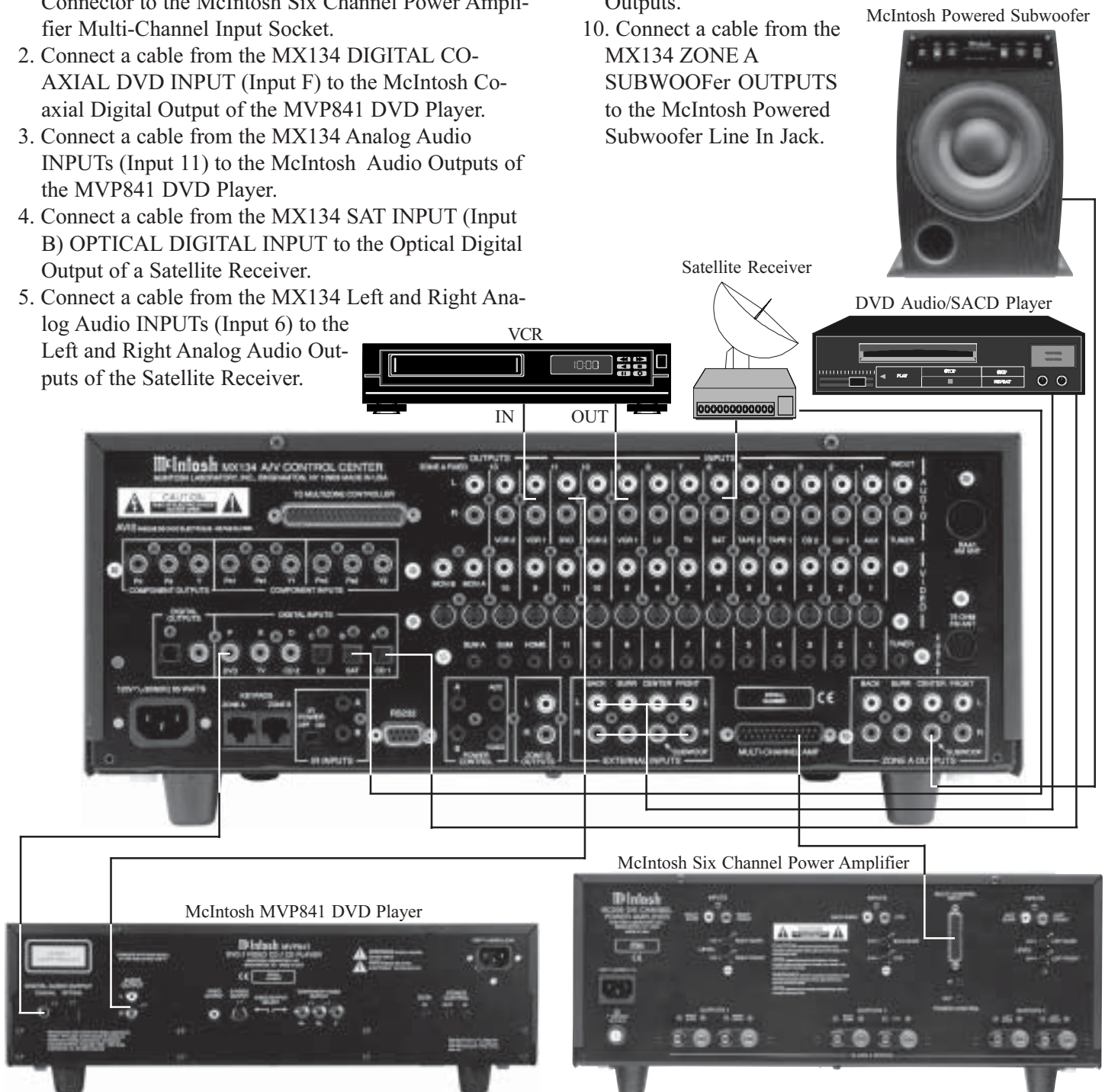

How to Connect Video Components

There are three types of Video Signals that can be connected to and selected by the MX134; Composite, S-Video and Component. The built-in Digital Video Processing Circuitry can Up-Convert the desired Composite Input to S-Video; it will also Up-Convert the desired Composite or S-Video Inputs to Component Video. Connect all of the available Source Component Video Outputs (Component, S-Video and Composite), using the appropriate Video Cables to the MX134. This will assure that video is available to the Zone B and VCR Outputs.

1. Connect video cables from the MX134 DVD VIDEO INPUTS to the McIntosh MVP841 DVD Player.
2. Connect video cables from the MX134 SAT INPUTS to the Video Outputs of a Satellite Receiver.

3. Connect video cables from the MX134 VCR1 INPUTS to the VCR Video Outputs.
4. Connect video cables from the MX134 VCR1 OUTPUTS to the VCR Video Inputs.
5. Connect video cables from the MX134 CD1 INPUT to the Video Outputs of the DVD-Audio/SACD Disk Player.
6. Connect video cables from the MX134 COMPONENT Video OUTPUTS to the Monitor/TV Component Video Inputs.

Note: If the Monitor/TV does not have Component Video Inputs, then connect the MX134 MON A S Video or Composite Output(s) instead.

Note: If the MX134 A/V System Control Center has the TMI AM/FM Tuner Module installed, proceed to page 54 for How to Connect Antennas Information.

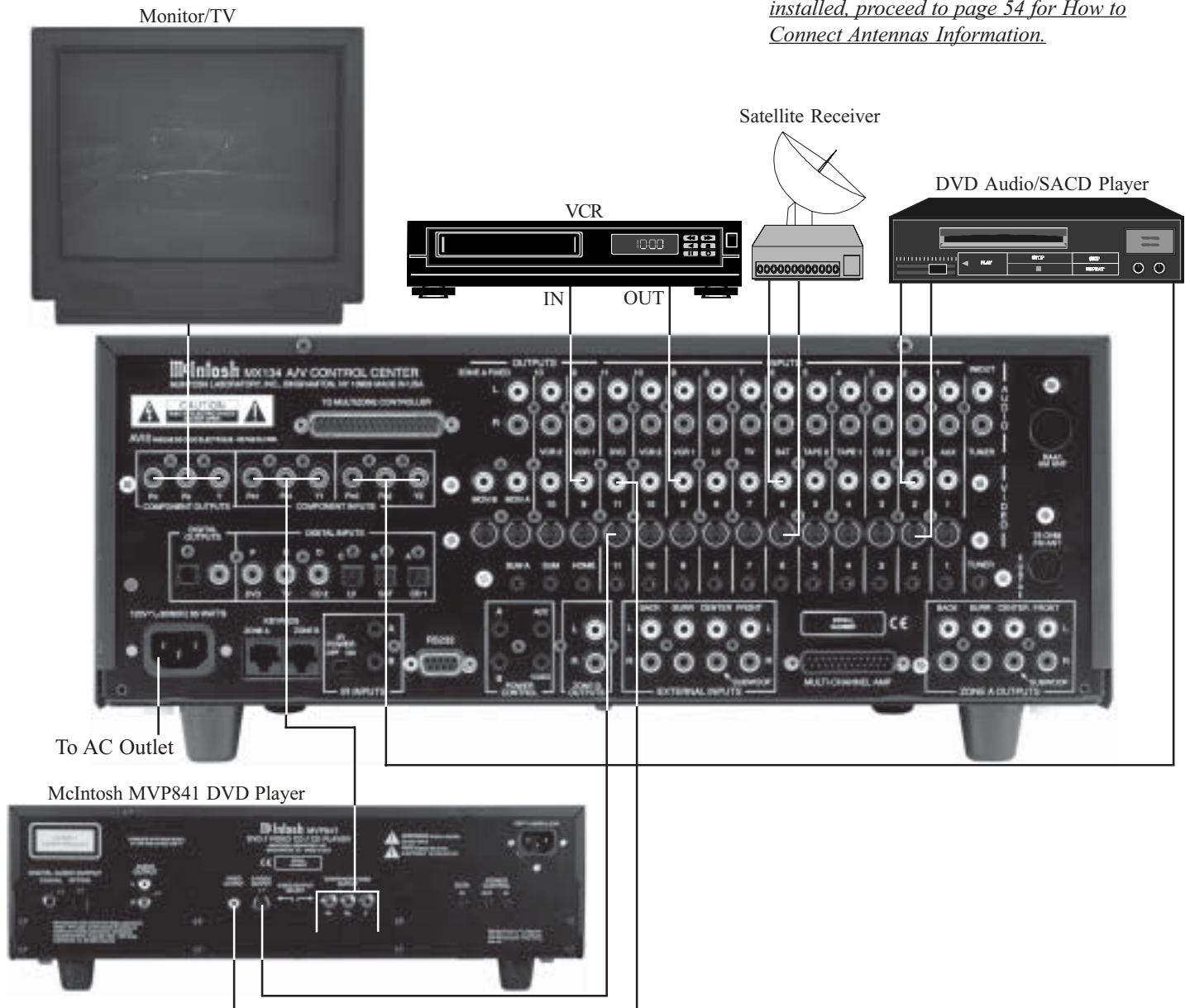

How to Connect for Zone B

The MX134 is a Dual Zone A/V Control Center. For Zone B activation a McIntosh Sensor or Keypad together with a Power Amplifier and Loudspeakers are required. To provide the best video quality for Zone B, it is important to use high quality cables and keep the cable lengths as short as possible. If S-Video Connections are used, make sure that the cable's signal carrying wires are individually shielded.

Note: If Zone B will not be connected at this time, proceed to step 5.

1. Connect a cable from the MX134 POWER CONTROL B Jack to the McIntosh Power Amplifier Power Control In Jack.
2. Connect a cable from the MX134 ZONE B OUTPUTS Left and Right to the McIntosh Power Amplifier Left and Right Inputs.

3. Connect a cable from the MX134 KEYPADS ZONE B to the McIntosh Keypad.
4. Connect a cable from the MX134 MON B S-Video Socket to the Monitor/TV video input.
5. Connect the MX134 to a live AC Outlet.

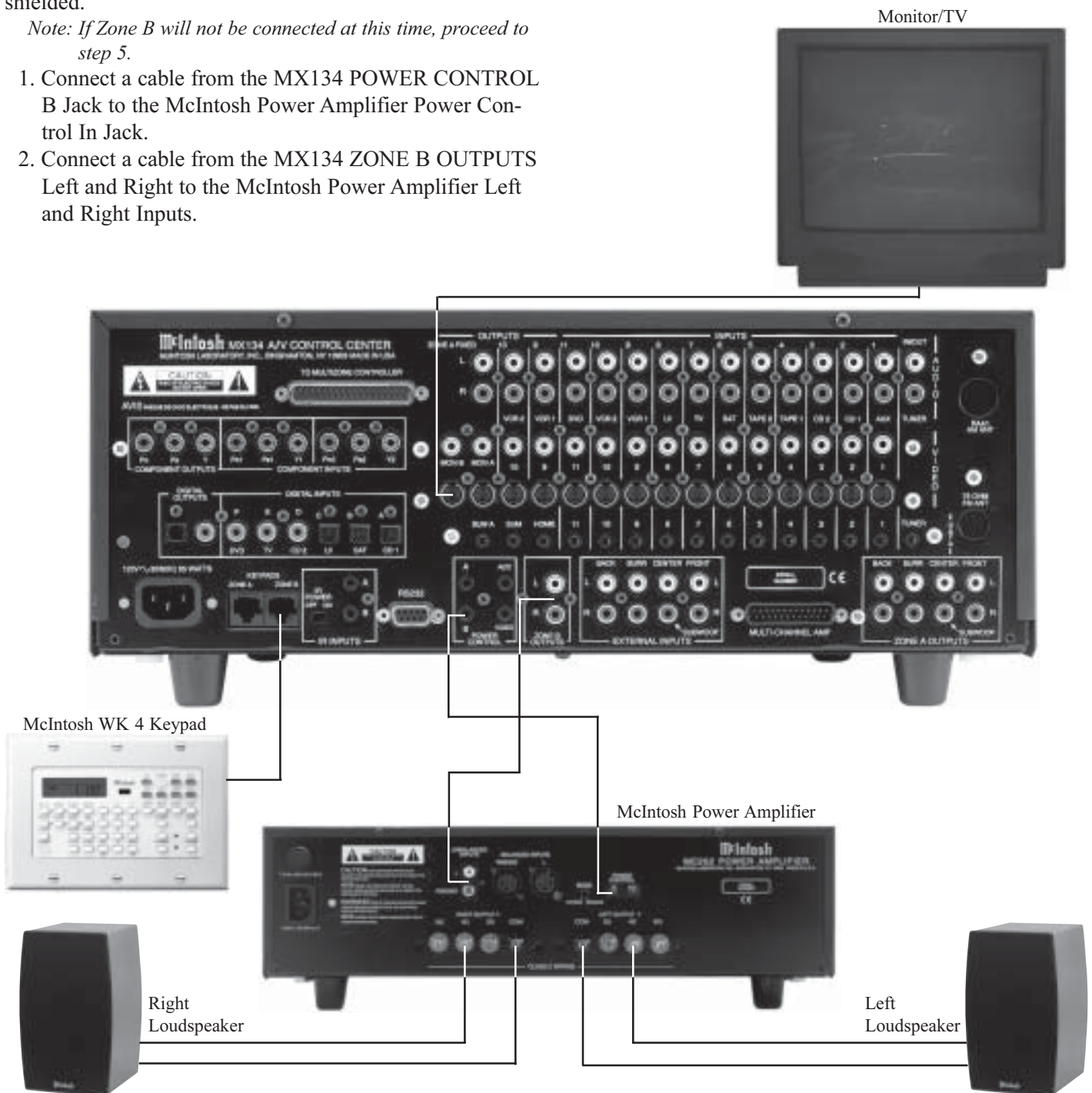

Allows up or down adjustment for each trim parameter

Selects which of the eleven Audio/Video Sources or Tuner Signal is available for VCR Outputs, Zone B Audio Outputs and MONitor B Video Outputs

Selects which of the eleven Audio/Video Sources or Tuner Signal is available at the Zone A Audio Outputs, Component and MONitor A Video Outputs

Adjusts the Listen Volume Level of all eight channels



IR (Infra Red) Sensor accepts IR signals directly from the MX134 Remote Control

Selects the parameter for making audio and front panel display adjustments

Selects the desired audio operating mode and selects the external eight channel input

Blocks input selection commands coming from INPUT B (Zone B) to prevent interrupting a recording process

Allows for the storing into memory various MX134 Settings

Turns the MX134 On and Off, or resets all the MX134 microprocessors

Move Up or Down through various selections and for Tuning Up or Down the AM or FM Broadcast Band when the optional TM1 Tuner Module is installed

Selects different Back Channel Modes of operation



Press to go into Setup Mode to change the settings

Move Left or Right through selections and for scrolling through the Tuner Presets stored in memory, when the optional TM1 Tuner Module is installed

Switches all AC Power On or Off

Switches Off the entire multizone system

Allows for the selection of various MX134 Functions

Activates the volume compression circuit, supported by selected Dolby Digital sound tracks

Indicates which Trim Parameter has been selected

Indicates Input Selection Status, Volume, Trim Adjustments, Surround Modes, Setup Functions. The Tuner Functions are displayed when the Optional TM1 Module is installed

Indicates which Surround Mode is in use

Indicates the name of the Sound Processing Format that is in use

Indicates the Listen Output Format and which channels are active; L (Left Front), C (Center), R (Right Front), SUB (Subwoofer), LS (Left Surround), BS (Back Surround) and RS (Right Surround)



Indicates when Record Lock is active

Indicates when the THX Reference Acoustic Volume Levels have been reached

Indicates when the Late Night Processing has been selected

Indicates the Format of the Incoming Signal and which channels are active; L (Left Front), C (Center), R (Right Front), LFE (Low Frequency Effects), LS (Left Surround), S (Pro Logic Surround) and RS (Right Surround)

Indicates when the Input Source selected is processing a Digital Signal

Indicates when the MX134 is in Standby/On Mode

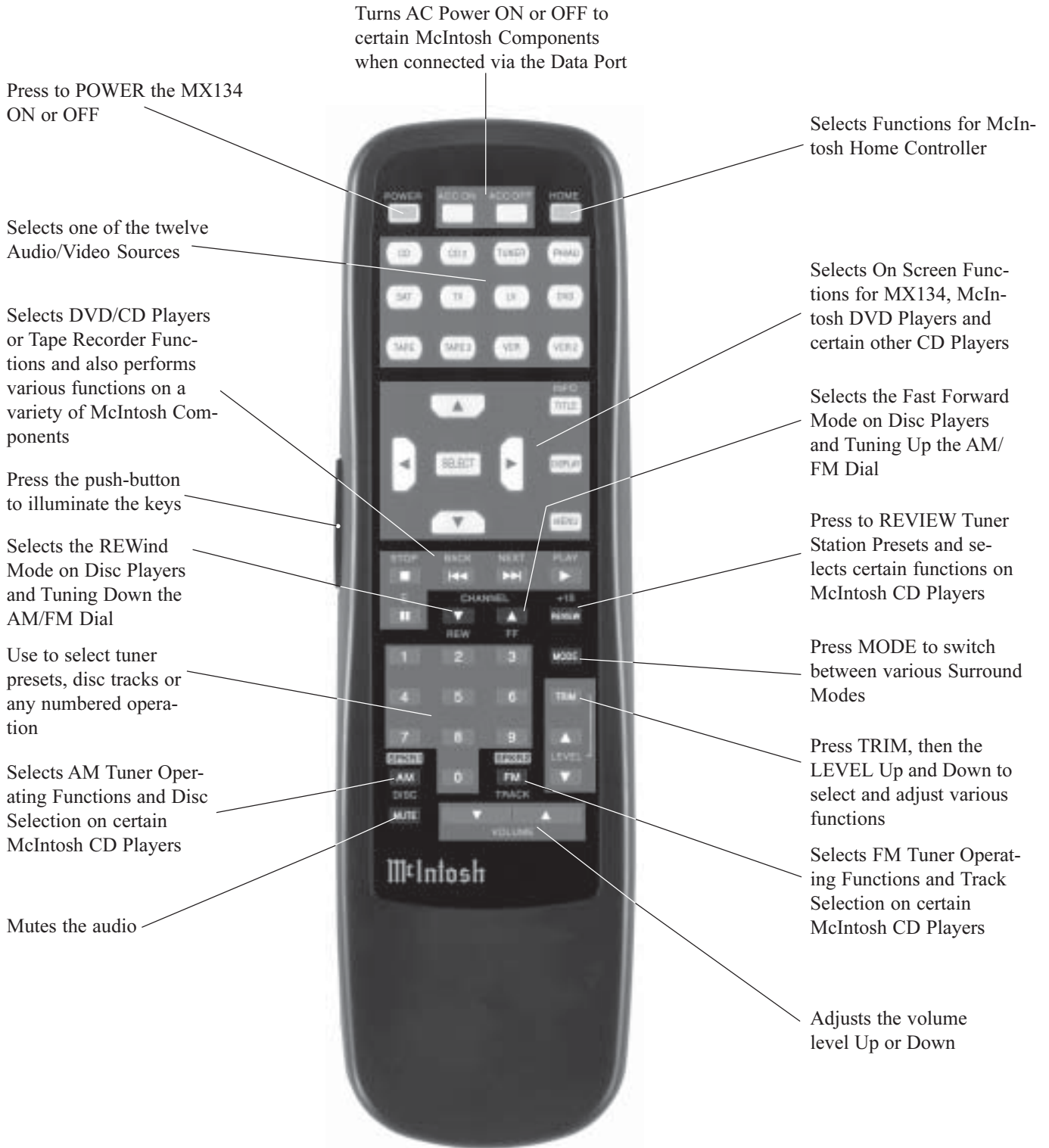

How to Operate by Remote Control

The supplied Remote Control is capable of directly controlling the functions of contemporary McIntosh Source Components connected to the MX134. Earlier McIntosh source components and other brand source components can be controlled by the MX134 with the addition of a McIntosh Remote Control Translator (RCT) and/or optional UR12 Touch Screen Remote Control.

Note: Your McIntosh Dealer can assist you with the installation and operation of the Remote Control Translator (RCT).

Mute

Press the MUTE Push-button to mute audio in the Zone where the command is issued. The VCR OUTPUTS are not affected by the MUTE function. The MX134 Front Panel Alphanumeric Display will indicate the word Mute for Zone A. Press MUTE a second time to unmute audio.

Mode

Press the MODE Push-button to select the Surround Mode from Mono to THX Cinema plus External Mode for listening to an Eight Channel Analog Audio Source.

Trim

Press the TRIM Push-button, followed by the LEVEL Up▲ or Down▼ Push-button to select various sound adjustments and MX134 Setup Settings.

Input Source Selection

Press any of the twelve Input Push-buttons to select a program source, both audio and video.

Disc and Tape Functions

Use these push-buttons to operate a DVD Player, CD Player, CD Changer or Tape Recorder.

Numbered Push-buttons

Press Push-buttons 0 through 9 to access tuner station presets or CD tracks/discs.

Disc and Track

Use the DISC and TRACK Push-buttons when a CD Player or changer is being used.

Tuner Push-buttons

Press the AM or FM Push-button to select the desired broadcast band. Press and release the Channel Up▲ or Down▼ Push-button to move from station to station. Press and hold a Channel Up▲ or Down▼ Push-button to move continuously from station to station. Press REVIEW to

start the automatic brief audition of each of the presets stored in the tuner memory. Press REVIEW a second time to stop on a station preset and exit the Review process.

Note: The above Tuner Function requires either the optional TMI Tuner Module installed in the MX134 or an external McIntosh Tuner connected to the MX134.

Volume

Press the Up▲ or Down▼ VOLUME Push-button to raise or lower the listening volume level.

Note: The VCR OUPUTS are not affected by volume changes.

Acc On

Press ACC ON to turn the power ON to a McIntosh Disc Player.

Acc Off

Press ACC OFF to turn the power OFF to a McIntosh Disc Player.

E

Press E to perform various functions on a variety of McIntosh Components. It will also pause the playing of a disc or tape player.

Lighting

Press and release the LIGHTING Push-button to momentarily illuminate the upper half of the Remote Control Push-buttons.

Note: While the LIGHTING Push button is being depressed, the Remote Control will be unable to send a remote command. When the LIGHTING Push button is released the push buttons will continue to stay illuminated for approximately three seconds thus allowing you to send the desired command. If any of the translucent push buttons are depressed, they will continue to stay illuminated for approximately three seconds.

Optional Remote Control

The McIntosh UR12 Touch Screen Remote Control combines a Multi-Page LCD Touchscreen, joystick navigation and easy to use command macros for operating all the components in your system. See your McIntosh Dealer for additional information.



How to Operate the Setup Mode

Your McIntosh MX134 has been factory configured for default operating settings that will allow immediate enjoyment of superb video and high fidelity audio without the need for further adjustments.

If you wish to make changes to the factory default settings (refer to the adjacent page), a System Setup Feature is provided to customize the operating settings using On Screen Menus.

Notes:

1. To use the On Screen Menu feature, the MX134 MON A Video OUTPUT or COMPONENT Video OUTPUTS must be connected to the video input of a Monitor/TV.
 2. Any adjustments made to the SPEAKER settings must be performed in the correct sequence, since they are interactive.
 3. Follow the sequence listed in the MAIN SYSTEM SETUP MENU for these adjustments.
1. Press the POWER switch to ON, the Red LED above the STANDBY/ON Push-button lights to indicate the MX134 is in Standby mode. To Turn On the MX134 press the STANDBY/ON Push-button. The title MUTE will appear on the Front Panel Alphanumeric Display for approximately two seconds after turn on, with the Output Muted. Refer to figures 1, 2 & 3.

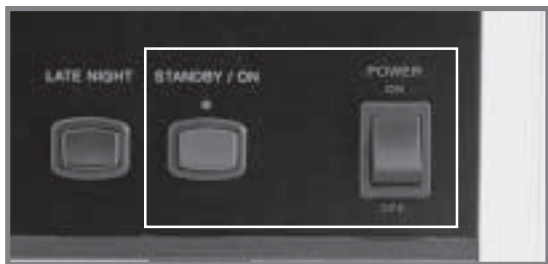

Figure 1

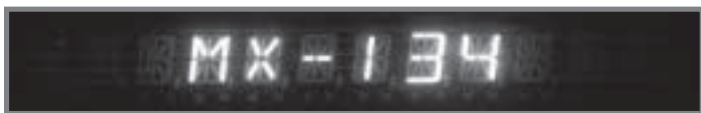

Figure 2

Notes: For normal operation, turn the MX134 On and Off with the Standby/On Push button. You may also turn on the MX134 by simply pressing the Power Push button on the Remote Control. If the A/V System Controller is not going to be used for an extended period of time, turn off all AC Power with the Power Switch. When the MX134 Main POWER Switch is first switched ON, the Front Panel Alphanumeric Display will indicate MX 134 and the Front Panel Nomenclature will illuminate for about two seconds, if the internal microprocessors are functioning properly. The MX134 will then go into the Standby Mode, waiting to be switched On.

2. Press and hold the MX134 Front Panel SETUP Push-button approximately three seconds to enter the Setup Mode. The word SETUP will appear on the Front Panel Alphanumeric Display and the MAIN SYSTEM SETUP Menu will appear on the Monitor/TV Screen. Refer to figures 4, 5 & 6.

3. Access the desired Setup Menu by pressing the Up▲ or Down▼ directional push-buttons followed by the SELECT Push-button on the supplied Remote Control. The desired Setup Menu will then appear on the Monitor/TV Screen. Use the Up▲ or Down▼ directional push-buttons to select the menu item and press the Left◀ or Right▶ directional push-buttons to change the current setting. Refer to figure 3.

4. After all adjustments are complete, select EXIT by pressing the Up▲ or Down▼ directional push-buttons on the remote control. Return to the MAIN SYSTEM SETUP Menu by pressing the SELECT Push-button.
5. Exit the MAIN SYSTEM SETUP Menu by pressing the Up▲ or Down▼ directional push-buttons followed by the SELECT Push-button.



Figure 3



Figure 4



Figure 5



Figure 6

6. If adjustments have been performed, the Adjustment Acceptance Menu will appear on the Monitor/ TV screen asking if you want to save the adjustments in memory. Use the Up▲ or Down▼ directional push-buttons to select YES to save, or NO to not save, then press the SELECT Push-button to exit the Setup Mode and return to normal operation. Refer to figure 7.

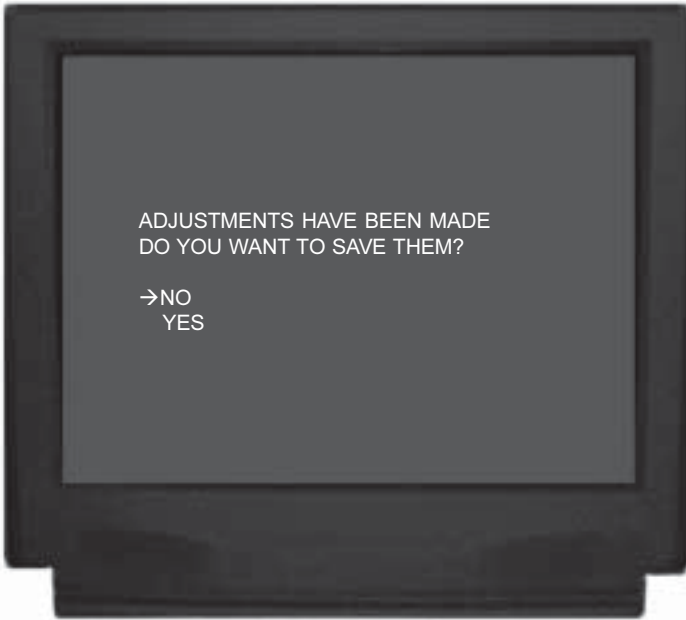

Figure 7

Default Settings

The following listings indicate the factory default settings. Refer to the listed page number for instructions on how to change a default setting:

Speaker Size:

<u>Speaker Type</u>	<u>Speaker Setting</u>	<u>Refer to Page</u>
Front	Small (THX)	25
Center	Small (THX)	25
Surround	Small (THX)	25
Back Surround	Small2 (THX)	25
Subwoofer ¹	Yes	25
Sub Crossover	80	25
Mc Bass Mode	Off	25

Speaker Time Delay:

<u>Speaker Location</u>	<u>Viewing Distance</u>	<u>Refer to Page</u>
Left Front	10 feet	27
Center	10 feet	27
Right Front	10 feet	27
Right Surround	10 feet	27
Back Right Surround	10 feet	27
Back Left Surround	10 feet	27
Left Surround	10 feet	27
Subwoofer	10 feet	27

Speaker Level:

<u>Speaker Location</u>	<u>Initial Level</u>	<u>Refer to Page</u>
Left Front	0	28
Center	0	28
Right Front	0	28
Right Surround	0	28
Back Right Surround	0	28
Back Left Surround	0	28
Left Surround	0	28
Subwoofer	0	28

¹The Low Frequency Effect (LFE) Sound Information is usually assigned to the Subwoofer Channel. If the Subwoofer Channel is switched Off and one or more of the Front Channel Loudspeakers are set to Large in the Speaker Size Setup Menu, the LFE Sound Information will be redirected to the Large Loudspeaker(s).

Analog Inputs (Zones A and B):

<u>Number</u>	<u>Name</u>	<u>Refer to Page</u>
0	TUN (1*)	30
1	AUX (1*)	30
2	CD1	30
3	CD2	30
4	TAPE 1	30
5	TAPE 2	30
6	SAT (1*)	30
7	TV (1*)	30
8	LV (1*)	30
9	VCR 1	30
10	VCR 2	30
11	DVD (1*)	30

Digital Inputs (Zone A):

<u>Letter</u>	<u>Type</u>	<u>Name</u>	<u>Refer to Page</u>
A	Optical	CD 1	31
B	Optical	SAT (1*)	31
C	Optical	LV (1*)	31
D	Coaxial	CD 2	31
E	Coaxial	TV (1*)	31
F	Coaxial	DVD (1*)	31

Component Video Inputs (Zone A):

<u>Number</u>	<u>Name</u>	<u>Refer to Page</u>
1	SAT (1*)	32
2	DVD (1*)	32

Video Power Control:

<u>Number</u>	<u>Power Control</u>	<u>Refer to Page</u>
1 - 11	ON	32

Video Input Converter:

<u>Number</u>	<u>Conversion</u>	<u>Refer to Page</u>
1 - 11	OFF	33

Audio Functions:

<u>Description</u>	<u>Initial Setting</u>	<u>Refer to Page</u>
Input B Record (Zone B)		
Turn-On-Volume	20	37

Back Surround Modes (Zone A):

<u>Processing Mode</u>	<u>Sound Field Mode</u>	<u>Refer to Page</u>
THX Surround	AUTO	36
DTS Matrix	AUTO	36

Advanced Digital Settings (Zone A):

<u>Function</u>	<u>Setting</u>	<u>Refer to Page</u>
Manual Override	OFF	38
Digital Lock	ON	38
DTS Unmute Delay	ON	38

Advanced Zone Control Setting (Zone A):

<u>Function</u>	<u>Setting</u>	<u>Refer to Page</u>
Input Select Power On	ON	39

* Indicates an implied number, which will apply only when a second component of the same type is assigned an input.

How to Adjust for Loudspeaker Size

A Home Theater System can include a variety of Loudspeakers with various capabilities. The LARGE listing refers to the Loudspeaker's capability for reproducing bass frequencies down to 35Hz within -3dB of the midrange frequencies. If a Loudspeaker can not reproduce bass frequencies down to 35Hz within -3dB of the midrange frequencies, it is considered SMALL. If you do not have a Subwoofer, you must have Front (Left and Right) Loudspeakers that are LARGE in order to hear the low frequencies below the Subwoofer Crossover Setting of 80Hz. If you are unsure as to the bass performance capabilities of your Loudspeakers, select the SMALL setting.

1. Press and hold the Front Panel SETUP Push-button approximately three seconds to enter the Setup Mode. The word SETUP will appear on the MX134 Front Panel Alphanumeric Display and the MAIN SYSTEM SETUP Menu will appear on the Monitor/TV screen. Refer to figure 6 on page 23.

2. Using the Up▲ or Down▼ directional push-buttons, select Speaker Size on the On-Screen Menu, followed by the SELECT Push-button on the Remote Control. Refer to figure 8.

Notes: The very first time the SPEAKER SIZE MENU is accessed, the factory default settings will be indicated. In the Speaker Size Menu Setting Options, the number after the name of Small or Large refers to quantity of Loudspeakers. If the setting for the Back Surround Loudspeaker is Small 1, only the Zone A Back Output Left Channel will have audio output.

3. Select the appropriate Loudspeaker location and type by using the Up▲ or Down▼ directional push-buttons to select first the menu item and then press the Left◀ or Right▶ directional push-buttons to change the current setting.

Notes: When the Front Loudspeakers are set to Small, the options in the Speaker Size Setup Menu for the Center and Surround Loudspeakers are Small or None; the Subwoofer Loudspeaker will be set to the On position. If the Surround Loudspeakers are set to Small, the options in the Speaker Size Setup Menu for the Back Surround Loudspeaker are Small 1(BSL), Small 2(THX) or None. When the Small 1 (BSL) setting is selected, the BACK Surround Right Channel ZONE A OUTPUT will be switched Off.

4. When all of the settings on the SPEAKER SIZE MENU agree with the Loudspeakers in your Home Theater System, perform the Sub Crossover and/or the MC Bass Mode adjustments below or if no adjustments are needed, then continue to the SPEAKER TIME DELAY Settings. If you do not wish to perform SPEAKER TIME DELAY adjustments at this time, select MAIN

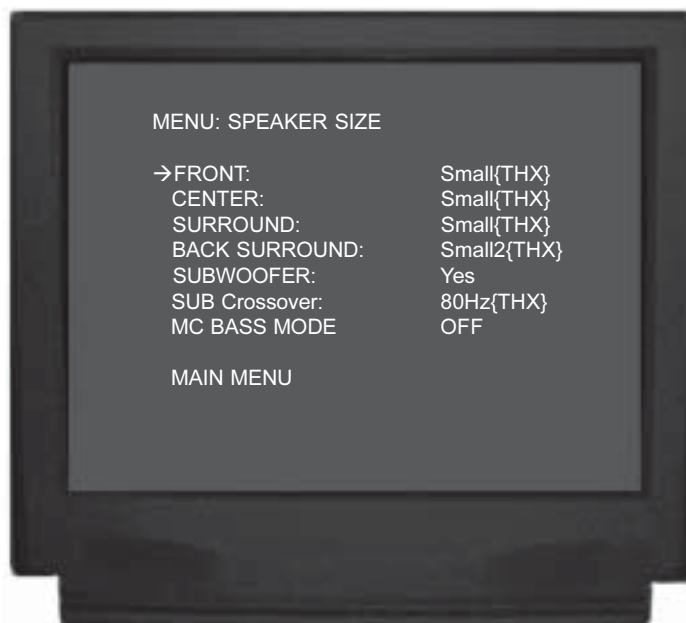

Figure 8

MENU from the menu. The MAIN SYSTEM SETUP Menu will reappear on the Monitor/TV screen and proceed to the next step.

5. Select EXIT from the MAIN SYSTEM SETUP Menu. If you are satisfied with the changes that you may have made, select YES to save those changes or NO not to save them. The MX134 will then return to normal operation. Refer to figure 7 on page 25.

Sub Crossover

The MX134 incorporates a built-in Electronic Crossover. The Crossover will redirect all of the audio frequencies below the crossover frequency setting to the Subwoofer and all the frequencies above the setting to the appropriate remaining Home Theater Loudspeakers. The default setting for the SUB CROSSOVER frequency setting is 80 Hz, which is the correct frequency for most Home Theater Loudspeaker Systems. Refer to figure 8 and perform the following steps to change the setting.

6. Using the Up▲ or Down▼ directional push-buttons, select SUB CROSSOVER from the Speaker Size On-Screen Menu, followed by pressing the Left◀ or Right▶ directional push-buttons to change the crossover frequency to the desired setting.

Notes: The range of adjustment is from 60Hz to 120Hz in 10Hz increments. When the Input Source is Analog and the Surround Mode is set to STEREO (the Alphanumeric Front Panel Display will indicate PURE STEREO) the crossover frequency will default to 80Hz.

How to Adjust for Loudspeaker Size, con't

- Next perform the MC Bass Mode adjustment below or if no adjustment is needed, then continue to the SPEAKER TIME DELAY Settings. If you do not wish to perform SPEAKER TIME DELAY adjustments at this time, select MAIN MENU from the menu. The MAIN SYSTEM SETUP Menu will reappear on the Monitor/TV screen and proceed to the next step.
- Select EXIT from the MAIN SYSTEM SETUP Menu. If you are satisfied with the changes that you may have made, select YES to save those changes or NO not to save them. The MX134 will then return to normal operation. Refer to figure 7.



Figure 7

Mc Bass Mode

When a Home Theater System contains Loudspeakers that are referred to as Large, the Bass Management Circuitry will direct all the Low Frequency Sounds away from the Subwoofer and to the Large Loudspeakers. With the MC BASS MODE set to ON the Low Frequency Sounds are sent to both the Large Loudspeakers and to the Subwoofer, thus increasing the total low frequency output of the Home Theater System. The default setting for the MC BASS MODE is OFF. Refer to figure 8 and perform the following steps to switch it On.

Note: The MC BASS Mode is only active when the Source is either a Two Channel Analog or Digital Signal.

- Using the Up▲ or Down▼ directional push-buttons, select MC BASS MODE from the Speaker Size On-Screen Menu, followed by pressing the Left◀ or



Figure 8

Right▶ directional push-buttons to activate the circuit. Select MAIN MENU and the MAIN SYSTEM SETUP Menu will reappear on the Monitor/TV screen.

- Next continue to the SPEAKER TIME DELAY Settings. If you do not wish to perform SPEAKER TIME DELAY adjustments at this time, select MAIN MENU from the menu. The MAIN SYSTEM SETUP Menu will reappear on the Monitor/TV screen and proceed to the next step.
- Select EXIT from the MAIN SYSTEM SETUP Menu. If you are satisfied with the changes that you may have made, select YES to save those changes or NO not to save them. The MX134 will then return to normal operation. Refer to figure 7.

Loudspeaker Size		
Loudspeaker	Default Setting	New Setting
Front (L&R)	Small{THX}	
Center	Small{THX}	
Surround (L&R)	Small{THX}	
Back Surround	Small 2{THX}	
Subwoofer	Yes	
Sub Crossover	80Hz {THX}	
Mc Bass	Off	

How to Adjust Speaker Time Delay

The following Time Delay Adjustments will electronically compensate for different Loudspeaker distances from the Listening/Viewing Area. Refer to figure 9. Time delay is measured in feet. The delays can be adjusted from 1 feet to 20 feet in one foot increments for each Loudspeaker.

Note: Before performing the TIME DELAY adjustments, you must first have completed the SPEAKER SIZE adjustments.

1. Press and hold the Front Panel SETUP Push-button approximately three seconds to enter the Setup Mode. The word SETUP will appear on the MX134 Front Panel Display and the MAIN SYSTEM SETUP Menu will appear on the Monitor/TV screen. Refer to figure 6 on page 23.
2. Using the Up▲ or Down▼ directional push-buttons, select Speaker Time Delay on the On-Screen Menu, followed by the SELECT Push-button on the Remote Control. Refer to figure 10.

Note: The very first time the SPEAKER TIME DELAY MENU is accessed, the factory default settings will be indicated.

3. Measure the distance from the Listening/Viewing Area to each of the Loudspeakers. A table has been provided to record the measurements and settings.

Note: A distance measurement that contains fractions of a foot, should be rounded up or down to the nearest whole number for this procedure.

4. Select the appropriate Loudspeaker location and type by using the Up▲ or Down▼ directional push-buttons to select first the menu item and then press the Left◀ or Right▶ directional push-buttons to change the cur-

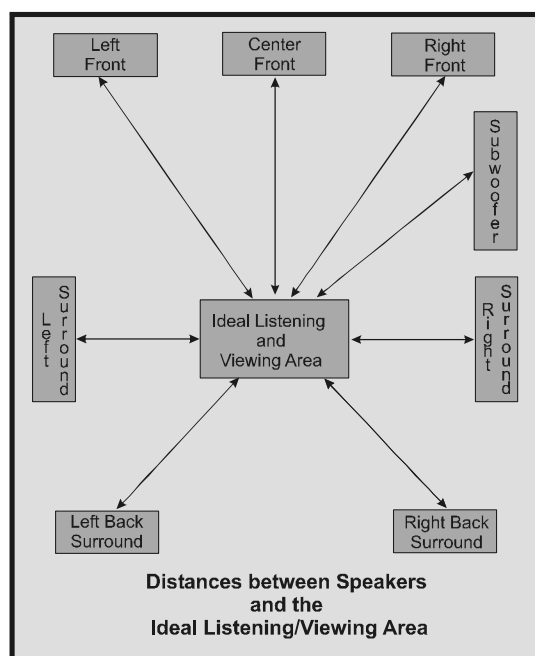

Figure 9



Figure 10

rent setting. When all of the settings on the SPEAKER TIME DELAY MENU agree with the Loudspeaker measured distances in your Home Theater System, select MAIN MENU. The MAIN SYSTEM SETUP Menu will reappear on the Monitor/TV screen.

5. Continue next to the SPEAKER LEVEL Settings. If you do not wish to perform SPEAKER LEVEL Adjustments at this time, select MAIN MENU from the menu. The MAIN SYSTEM SETUP Menu will reappear on the Monitor/TV screen and proceed to the next step.
6. Select EXIT from the MAIN SYSTEM SETUP Menu. If you are satisfied with the changes that you may have made, select YES to save those changes or NO not to save them. The MX134 will then return to normal operation. Refer to figure 7 on page 26.

Loudspeaker Time Delay		
Location	Default Setting	New Setting
Left Front	10 feet	
Center	10 feet	
Right Front	10 feet	
Right Surr	10 feet	
Right Back Surr	10 feet	
Left Back Surr	10 feet	
Left Surround	10 feet	
Subwoofer	10 feet	

How to Adjust Speaker Levels

A properly setup Home Theater Surround Sound System should have all Loudspeaker levels adjusted to the same starting reference volume level in the Listening/Viewing Area. The MX134 includes a built-in test signal generator, which can have its output switched into each Loudspeaker, either automatically or manually. The desired test signal volume levels of each Loudspeaker can be determined, in the Listening/Viewing area, either by listening or with a sound pressure meter. Level adjustments are made in 1dB steps by using the MX134 Remote Control Left◀ and Right▶ Directional Push-buttons. The level can be adjusted over a plus or minus 12dB range.

Notes: Before adjusting the SPEAKER LEVELs, you FIRST must have performed the SPEAKER SIZE and SPEAKER TIME DELAY adjustments. The SPEAKER LEVEL On Screen Display will only indicate for channels that have been switched On in the SPEAKER SIZE Menu. A sound level pressure meter will greatly aid in adjusting the Loudspeaker levels.

1. Press and hold the Front Panel SETUP Push-button approximately three seconds to enter the Setup Mode. The word SETUP will appear on the MX134 Front Panel Display and the MAIN SYSTEM SETUP Menu will appear on the Monitor/TV screen. Refer to figure 6 on page 23.
2. Using the Up▲ or Down▼ directional push-buttons, select Speaker Level on the On-Screen Menu, followed by the SELECT Push-button on the Remote Control. Refer to figure 11.
Note: The very first time the SPEAKER LEVEL MENU is accessed, the factory default settings will be indicated.
3. Determine whether you wish to use the Automatic or Manual Loudspeaker Level switching mode. For Automatic switching, proceed to Step 4. For manual switching proceed to Step 11 on the next page.

Automatic Loudspeaker Level Switching

4. Using the Up▲ or Down▼ directional push-buttons, select AUTOMATIC from the Speaker Level On-Screen Menu, followed by pressing the SELECT Push-buttons to activate the Automatic Loudspeaker Switching Mode. Refer to figure 12.
Note: The word OFF, located to the far right of the word AUTOMATIC, will switch to ON. The test signal will start cycling continuously through all Loudspeakers in 2 second intervals.
5. While in the Listening/Viewing area, note the volume levels from each of the Loudspeakers as the test signal switches. If you determine that the test signal volume is louder or softer in any of the Loudspeakers, the lev-



Figure 11

els should be adjusted so you hear the same test signal volume from all of the Loudspeakers.

Note: The Left Front Loudspeaker Volume Level can serve as a reference.

6. Adjust the volume of the test signal by pressing the Left◀ or Right▶ directional push-buttons on the Remote Control. If an adjustment is made on a Loudspeaker, there is an additional 2-second time interval before the system switches to the next Loudspeaker. As



Figure 12

a level is changed, the on-screen display instantly indicates the level change.

Note: If the level is increased or decreased, the display will indicate numbers or minus numbers.

7. As the test signal switches to succeeding Loudspeakers, repeat the level adjustment process until the test signal volume levels of all the Loudspeakers are the same. The Loudspeaker level cycling mode can be repeated as often as necessary.
8. Press the SELECT Push-button to switch Off the Automatic Loudspeaker Level Switching Mode.
9. Continue next to the INPUT SETUP. If you do not wish to perform INPUT SETUP Adjustments at this time, select MAIN MENU from the menu. The MAIN SYSTEM SETUP Menu will reappear on the Monitor/TV screen and proceed to the next step.
10. Select EXIT from the MAIN SYSTEM SETUP Menu. If you are satisfied with the changes that you may have made, select YES to save those changes or NO not to save them. The MX134 will then return to normal operation. Refer to figure 7 on page 23.

Manual Speaker Level Switching

11. Using the Up▲ or Down▼ directional push-buttons, select MANUAL from the Speaker Level On-Screen Menu, followed by pressing the SELECT Push-buttons to activate the Manual Loudspeaker Switching Mode. Refer to figure 13.
12. Adjust the volume of the test signal by pressing the Left◀ or Right▶ directional push-buttons on the Remote Control.

Note: The Left Front Loudspeaker Volume Level can serve as a reference. If the level is increased or decreased, the display will indicate numbers or minus numbers.

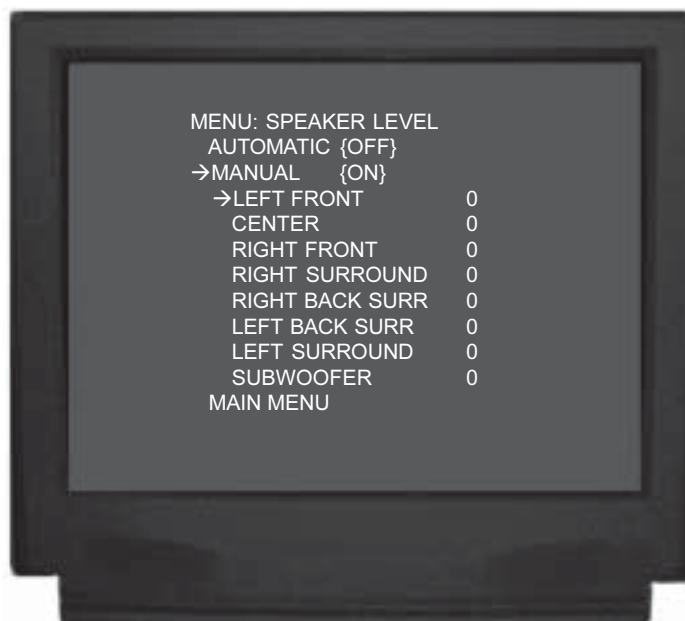

Figure 13

13. Using the Up▲ or Down▼ directional push-buttons, select the next Loudspeaker and perform the level adjusting procedure. Continue this for each of the remaining Loudspeakers. Repeat this as often as necessary until you are satisfied that the volume levels of all the Loudspeakers are the same.
14. Press the SELECT Push-button to switch Off the Manual Loudspeaker Level Switching Mode.
15. Continue next to the INPUT SETUP. If you do not wish to perform INPUT SETUP Adjustments at this time, select MAIN MENU from the menu. The MAIN SYSTEM SETUP Menu will reappear on the Monitor/TV screen and proceed to the next step.
16. Select EXIT from the MAIN SYSTEM SETUP Menu. If you are satisfied with the changes that you may have made, select YES to save those changes or NO not to save them. The MX134 will then return to normal operation. Refer to figure 7 on page 23.

Loudspeaker Levels		
Location	Default Setting	New Setting
Left Front	0dB	
Center	0dB	
Right Front	0dB	
Right Surround	0dB	
Right Back Surround	0dB	
Left Back Surround	0dB	
Left Surround	0dB	
Subwoofer	0dB	

How to Change the Input Setup

The MX134 has eleven Analog Audio Inputs numbered 1 through 11, six Digital Audio Inputs lettered A through F and two Component Video Inputs numbered 1 and 2. These inputs already have assigned titles and associations that will allow for immediate hookup, operation and enjoyment. If these starting assignments and associations do not match up with components in your system, they may be reassigned from the default settings. The following example will illustrate how to rename the AUX Input to DVD2 and assign it a Digital Input. When the Zone A or B Input Selector is rotated to select what was originally the AUX Input, DVD2 will now appear on the Front Panel Alphanumeric Display. The Video Power Control, Video Converter and Component Video can also be set for each Input.

- Notes:*
1. The Source Input Number 0 will always be assigned to the Tuner Input and can not be reassigned.
 2. Unused Inputs may be switched Off so that they will not appear when rotating through the input source choices using the Zone A or Zone B Input Selector and also will not be available when using the Remote Control or Keypad.
 3. Each Analog Audio/Video Input must have a unique title (type and number) assigned to it.
 4. Multiple Inputs of the same type must be assigned consecutively. Example, there can not be a DVD3 Input without first having DVD1 and DVD2 inputs.

1. Press and hold the Front Panel SETUP Push-button approximately three seconds to enter the Setup Mode. The word SETUP will appear on the MX134 Front Panel Display and the MAIN SYSTEM SETUP Menu will appear on the Monitor/TV screen. Refer to figure 6 on page 23.
2. Using the Up▲ or Down▼ directional push-buttons on the Remote Control, select Input Setup on the On-Screen Menu, followed by the SELECT Push-button. Refer to figures 14 and 15.
3. Using the Up▲ or Down▼ directional push-buttons, select SOURCE INPUT from the On-Screen Menu, followed by pressing the Left◀ or Right▶ directional push-buttons to select Input Number 1.

Note: The very first time the INPUT SETUP is accessed, the default settings will be indicated.

Analog Audio/Video Input Title

4. Using the Up▲ or Down▼ directional push-buttons, select TITLE, followed by pressing the SELECT Push-button. The On-Screen Menu will now change, allowing the current Input Title to be changed. Refer to figure 16.
5. Press the DVD Push-button on the Remote Control. The On-Screen Menu Display will now display the



Figure 14

DVD Input Name with a question mark symbol after it. Refer to figure 17.

6. Now press the Number 2 Push-button and the On-Screen Title Menu will indicate DVD2 for the number 1 Input Name. Refer to figure 18.
7. Repeat steps 4 thru 6 for any additional inputs that need to be reassigned using the desired Input Title (name and number).
8. Proceed to the Digital Input Setup.

If the re-ordering of Titles is desired to place frequently used inputs adjacent to one another, input(s) may be switched Off during the process. This is performed by pressing the Number 0 Push-button on the Remote Control in step five instead of an input name. The On-Screen Display will now indicate OFF for a TITLE. Refer to figure 19.

Notes: This same procedure can also be used for switching Off those inputs that have



Figure 15

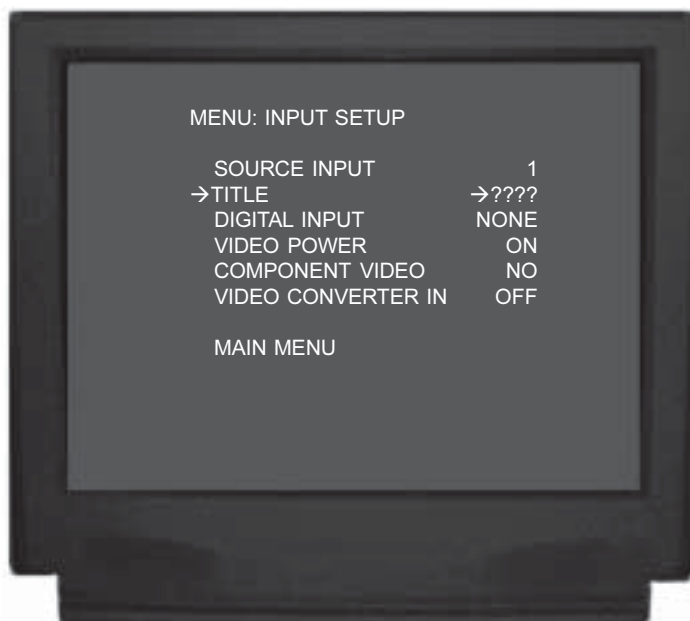

Figure 16

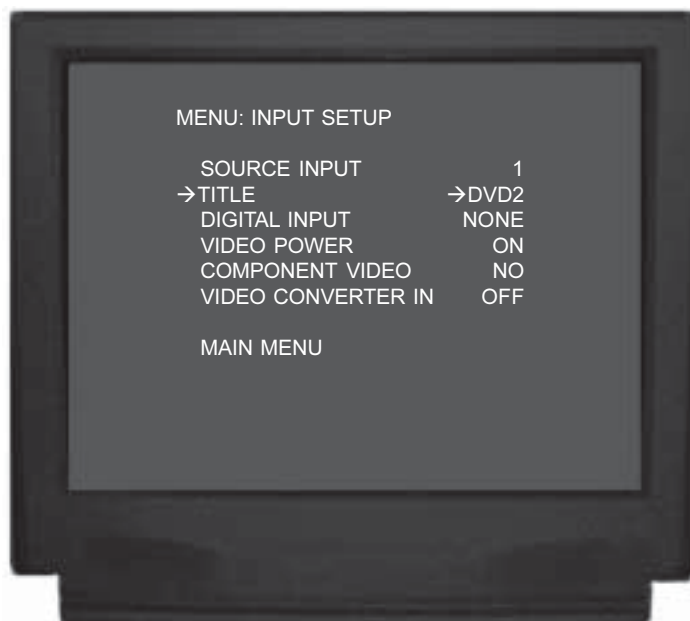

Figure 18

no components connected to them. If the MX134 is connected to a McIntosh Multizone System Controller refer to note 13 on page 5 for additional information about reassigning Inputs. If an Input Title has been retitled or switched off from the factory default setting and there is now a desire to return the Input to the original Title, press the specific Remote Control Input that matches the Title, followed by the Number 0 Push button. This will assure that only the desired Input Push button will need to be pressed, instead of the Input Name followed by the Input Number.

Digital Input

There are three Optical Digital Inputs and three Coaxial Digital Inputs available for assignment with any of the eleven Analog Audio/Video Inputs. The following example describes how to reassign Digital Input C, which by default has been assigned to Input Number 8 LV, over to the newly created DVD2 Input instead.

- Using the Up▲ or Down▼ directional push-buttons, select SOURCE INPUT from the On-Screen Menu, followed by pressing the Left◀ or Right▶ directional push-buttons to select the DVD2 Input Number 1. Re-

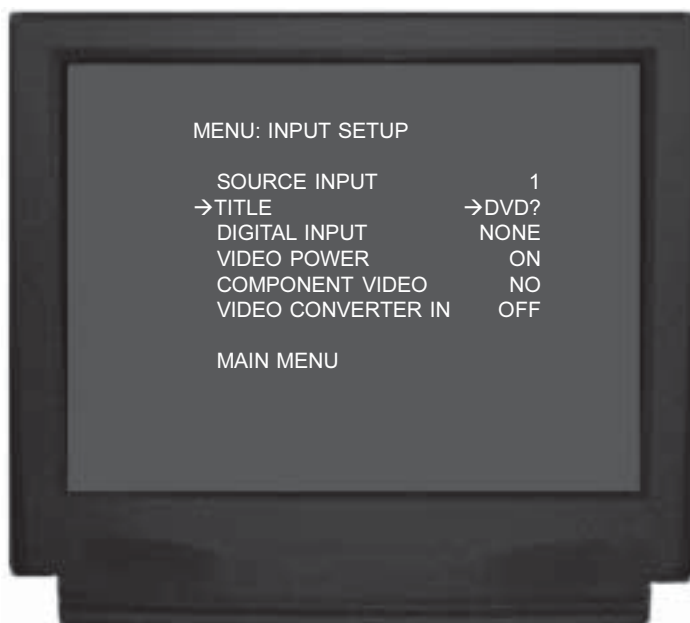

Figure 17



Figure 19

How to Change the Input Setup, con't

fer to figure 20.

- Using the Up▲ or Down▼ directional push-buttons, select DIGITAL INPUT on the On-Screen Menu, followed by pressing the Left◀ or Right▶ directional push-buttons to select the OPT C Digital Input. Refer to figure 21.
- Using the Up▲ or Down▼ directional push-buttons, select SOURCE INPUT from the On-Screen Menu, followed by pressing the Left◀ or Right▶ directional push-buttons to select the LV Input.
- Using the Up▲ or Down▼ directional push-buttons, select DIGITAL INPUT on the On-Screen Menu, followed by pressing the Left◀ or Right▶ directional push-buttons to select NONE.

Note: The MX134 allows for assigning a Digital Input to multiple Analog Audio/Video Inputs. For example, the Digital Input F can be assigned to both the DVD1 and CD2 Inputs. When the MX134 Input Selector is set to DVD and the McIntosh DVD/CD Player is playing a Movie Disc, the Dolby Digital Surround Sound Mode will be selected. Likewise, when the Input Selector is set to CD2 and the McIntosh DVD/CD Player is playing a CD Audio Disc the Music2 Surround Mode will process the music.

- Continue next to the VIDEO POWER Control. If you do not wish to perform VIDEO POWER Control Adjustments at this time, proceed to the Component Video Input next.

Video Power

The MX134 VIDEO POWER Control Setup allows selecting a specific Analog Audio/Video Input or all of them to activate the VIDEO POWER CONTROL Jack. This can be used to switch AC Power using McIntosh AC Power Controllers and other devices. By default all eleven Analog Audio/Video Inputs have the VIDEO POWER set to the ON Position. In the following example, the VIDEO POWER Setting for newly created DVD2 Input will be switched Off.

- Using the Up▲ or Down▼ directional push-buttons, select SOURCE INPUT from the On-Screen Menu, followed by pressing the Left◀ or Right▶ directional push-buttons to select the DVD2 Input Number 1.
- Using the Up▲ or Down▼ directional push-buttons, select VIDEO POWER on the On-Screen Menu, followed by pressing the Left◀ or Right▶ directional push-buttons to select OFF. Refer to figure 22.
- If you do not wish to perform COMPONENT VIDEO INPUT Adjustments at this time, proceed to Video Converter next.

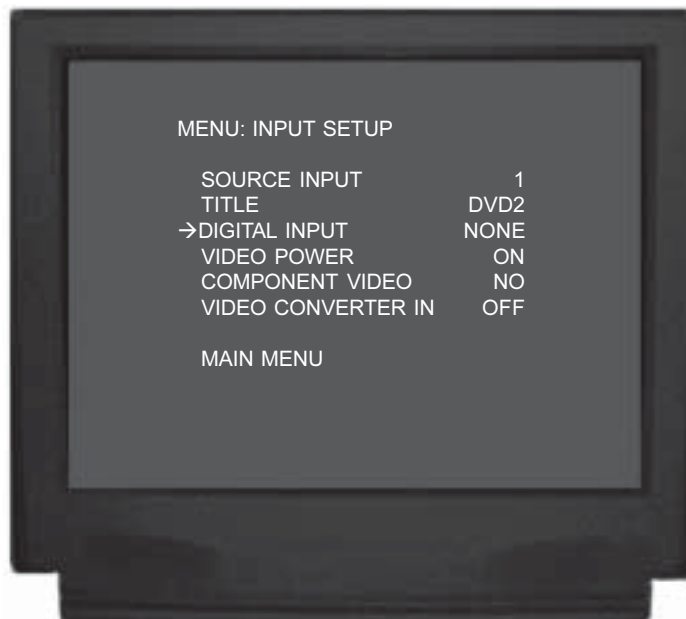

Figure 20

Component Video Input

The MX134 has Electronic Input Switching for two Component Video Sources. The Component Video Inputs can be assigned to any of the eleven Analog Audio/Digital Inputs in the Home Theater System. The following example describes how to reassign COMPONENT 1 IN Video Input, which by default has been assigned to SAT Input, over to the newly created DVD2 Input instead and switching the SAT Component Video Input to Off.

Note: The MX134 allows for assigning a Component Video Input to multiple Analog Audio/Digital Inputs. For



Figure 21

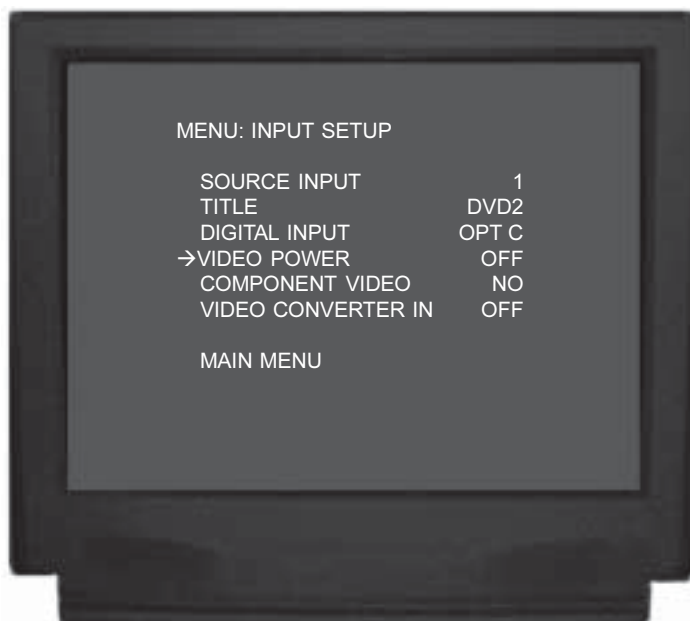

Figure 22

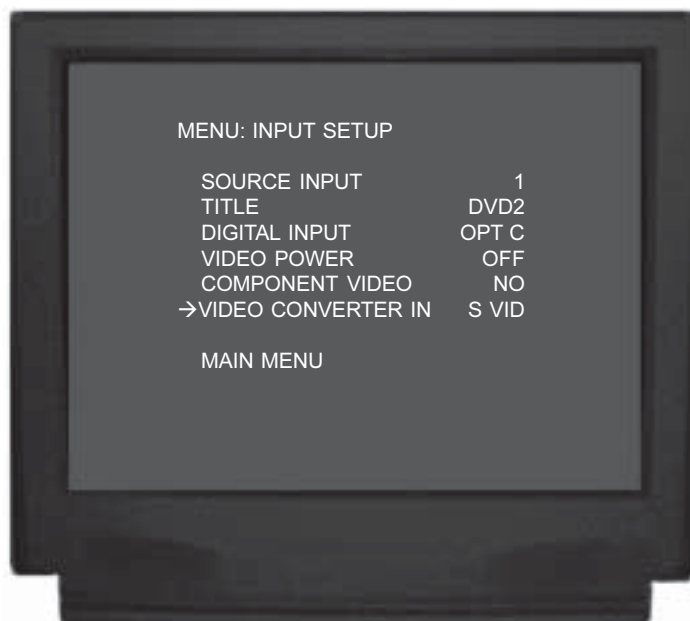

Figure 24

example, the Component Video Input 1 can be assigned to both the SAT and Tuner Inputs. This would allow viewing the Video from the SAT Input with Audio coming from a radio station.

- 17. Using the Up▲ or Down▼ directional push-buttons, select SOURCE INPUT from the On-Screen Menu, followed by pressing the Left◀ or Right▶ directional push-buttons to select the DVD2 Input, Number 1.
- 18. Using the Up▲ or Down▼ directional push-buttons, select COMPONENT VIDEO on the On-Screen Menu, followed by pressing the Left◀ or Right▶ directional

- push-buttons to select 1. Refer to figure 23.
- 19. Using the Up▲ or Down▼ directional push-buttons, select SOURCE INPUT from the On-Screen Menu, followed by pressing the Left◀ or Right▶ directional push-buttons to select the SAT Input.
- 20. Using the Up▲ or Down▼ directional push-buttons, select COMPONENT VIDEO on the On-Screen Menu, followed by pressing the Left◀ or Right▶ directional push-buttons to select OFF.
- 21. If you do not wish to perform VIDEO CONVERTER Adjustments at this time, proceed to step 25 on page 34.

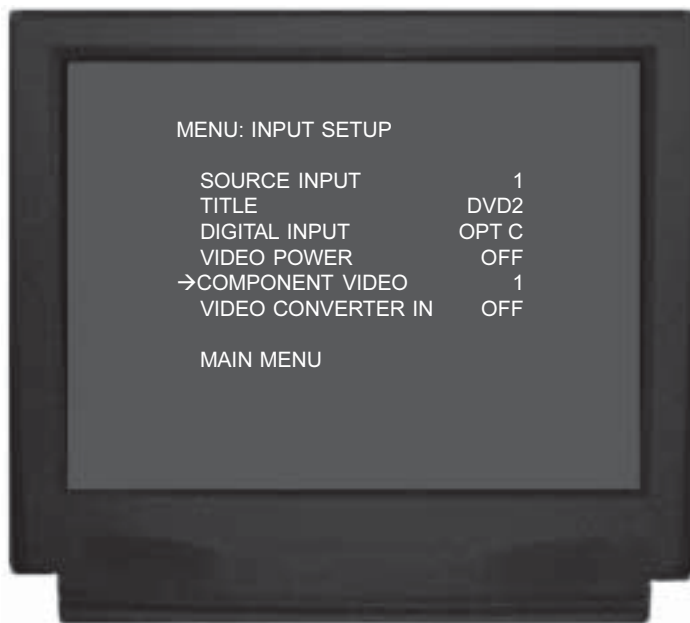

Figure 23

Video Converter

The MX134 Video Converter feature allows the Up-Conversions of Composite Video to S-Video and from S-Video to Component Video. This will provide better picture quality and will simplify video connections and operation. In the following example, the VCR1 Input has a S-Video Signal and it will be converted to Component Video.

- 22. Using the Up▲ or Down▼ directional push-buttons, select SOURCE INPUT from the On-Screen Menu, followed by pressing the Left◀ or Right▶ directional push-buttons to select the VCR1 Input, Number 9.
- 23. Using the Up▲ or Down▼ directional push-buttons, select COMPONENT VIDEO on the On-Screen Menu, followed by pressing the Left◀ or Right▶ directional push-buttons to select S-VID. Refer to figure 24.

24. Using the Up▲ or Down▼ directional push-buttons, select MAIN MENU on the On-Screen Menu and press the SELECT Push-button.
25. Continue next to the SURROUND MODE SETUP on page 36. If you do not wish to perform SURROUND MODE SETUP Adjustments at this time, select MAIN MENU from the menu. The MAIN SYSTEM SETUP Menu will reappear on the Monitor/TV screen and proceed to the next step.
26. Select EXIT from the MAIN SYSTEM SETUP Menu. If you are satisfied with the changes that you may have made, select YES to save those changes or NO not to save them. The MX134 will then return to normal operation. Refer to figure 7 on page 23.

Analog and Digital Audio Input Source Settings				
Number	Default Title	New Title	Default Digital Input	New Digital Input
0	TUNER		-	
1	AUX		-	
2	CD1		A-Optical	
3	CD2		D-Coaxial	
4	TAPE1		-	
5	TAPE2		-	
6	SAT		B-Optical	
7	TV		E-Coaxial	
8	LV		C-Optical	
9	VCR1		-	
10	VCR2		-	
11	DVD		F-Coaxial	

Video Inputs Source Settings							
Number	Title	Video Power Control		Component Video Source		Video Converter In	
		Default Setting	New Setting	Default Setting	New Setting	Default Setting	New Setting
0	TUNER	ON		-		OFF	
1	AUX	ON		-		OFF	
2	CD1	ON		-		OFF	
3	CD2	ON		-		OFF	
4	TAPE1	ON		-		OFF	
5	TAPE2	ON		-		OFF	
6	SAT	ON		1		OFF	
7	TV	ON		-		OFF	
8	LV	ON		-		OFF	
9	VCR1	ON		-		OFF	
10	VCR2	ON		-		OFF	
11	DVD	ON		2		OFF	

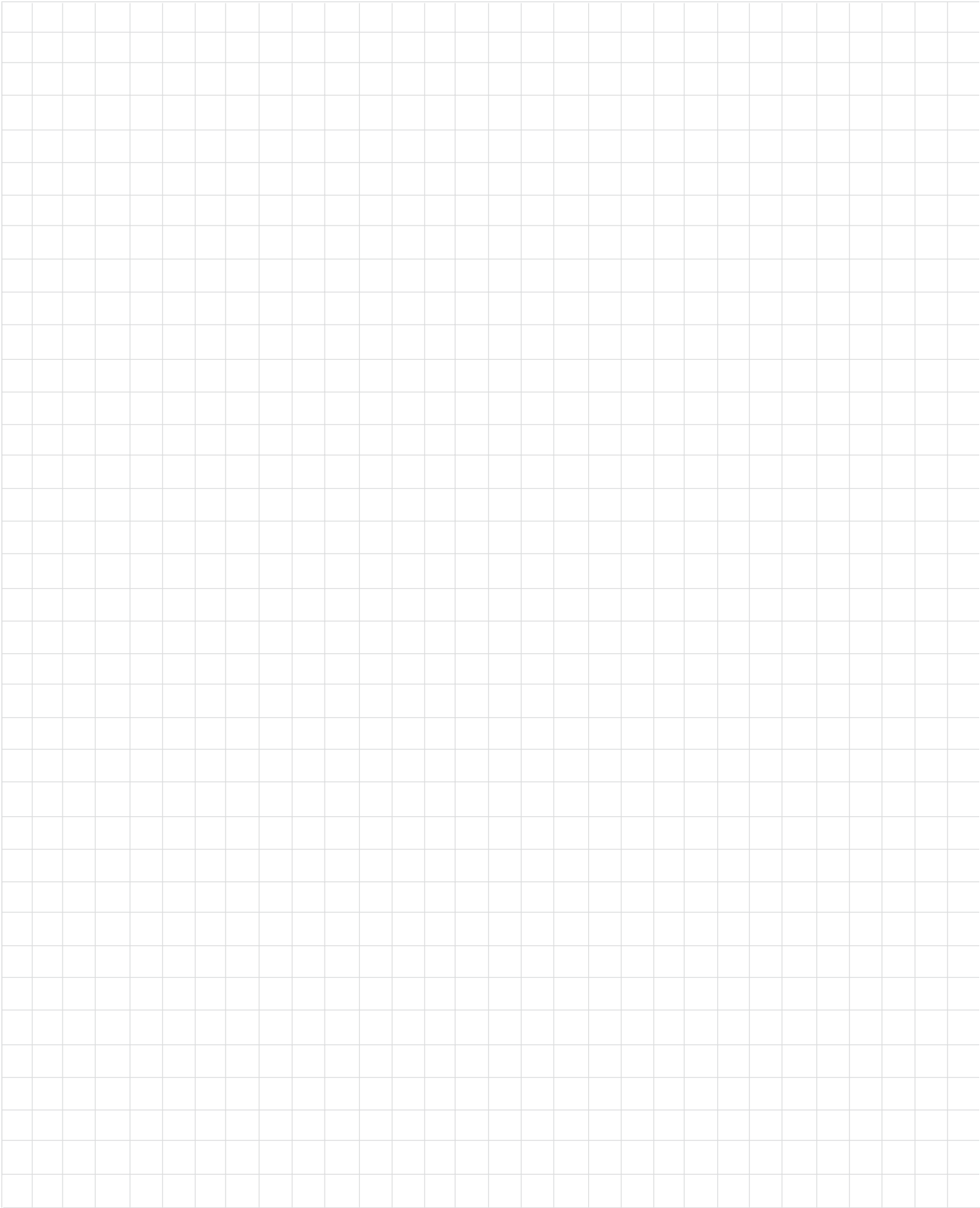

How to Change the Surround Mode Setup

The MX134 has Back Channel Surround Processing built-in thus allowing for an additional enhancement of Dolby Digital and DTS Movie Sound Tracks. There are three options for Back Channel processing; these include On, Off and Automatic.

In the AUTO Mode, the MX134 will automatically switch the Back Surround Sound Expander from Off to On when the Digital Signal contains the added sound track information along with the “Back Surround Digital Flag”. When in the ON Mode, any common or in phase Left/Right Surround Signal Information contained in the Left and Right Surround Channels will be expanded and sent to the Back Surround Loudspeaker(s). The OFF Mode switches the Back Surround Sound Decoder Off and no sound will be heard from the Back Surround Loudspeakers.

Note: If the Back Surround Sound Expander is set to the ON Mode and the sound track contains no common or in phase Left/Right Surround Signal Information in the Left and Right Surround Channels, the Back Channels will reproduce the Left and Right Surround Channels sound instead.

1. Press and hold the Front Panel SETUP Push-button approximately three seconds to enter the Setup Mode. The word SETUP will appear on the MX134 Front Panel Display and the MAIN SYSTEM SETUP Menu will appear on the Monitor/TV screen. Refer to figure 25.
2. Using the Up▲ or Down▼ directional push-buttons on the Remote Control, select Surround Mode Setup on the On-Screen Menu, followed by the SELECT Push-button. Refer to figure 26.
3. Using the Up▲ or Down▼ directional push-buttons, select THX SURR EX from the On-Screen Menu, followed by pressing the Left◀ or Right▶ directional push-buttons to select ON, OFF or AUTOMATIC.
4. Using the Up▲ or Down▼ directional push-buttons, select DTS-ES MATRIX from the On-Screen Menu, followed by pressing the Left◀ or Right▶ directional push-buttons to select ON, OFF or AUTOMATIC.
5. Continue next to the ZONE B SETUP. If you do not wish to perform ZONE B SETUP Adjustments at this time, select MAIN MENU from the menu. The MAIN SYSTEM SETUP Menu will reappear on the Monitor/TV screen and proceed to the next step.
6. Select EXIT from the MAIN SYSTEM SETUP Menu. If you are satisfied with the changes that you may have made, select YES to save those changes or NO not to save them. The MX134 will then return to normal operation. Refer to figure 7 on page 23.

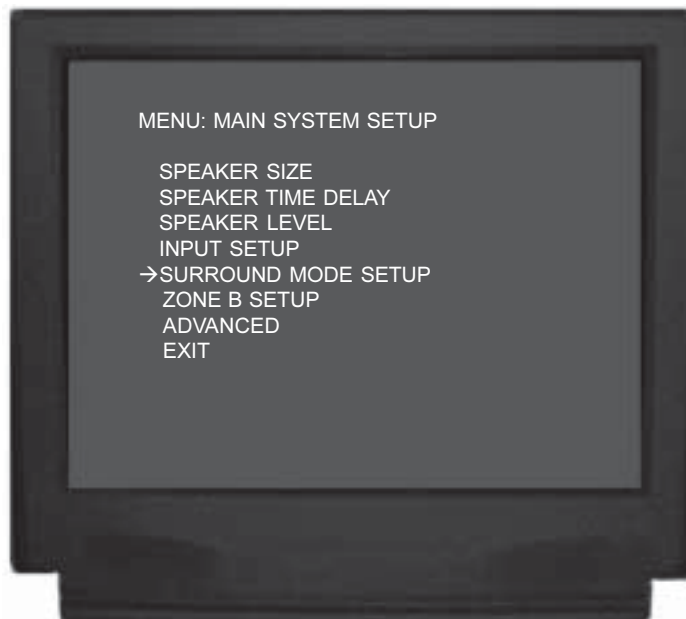

Figure 25

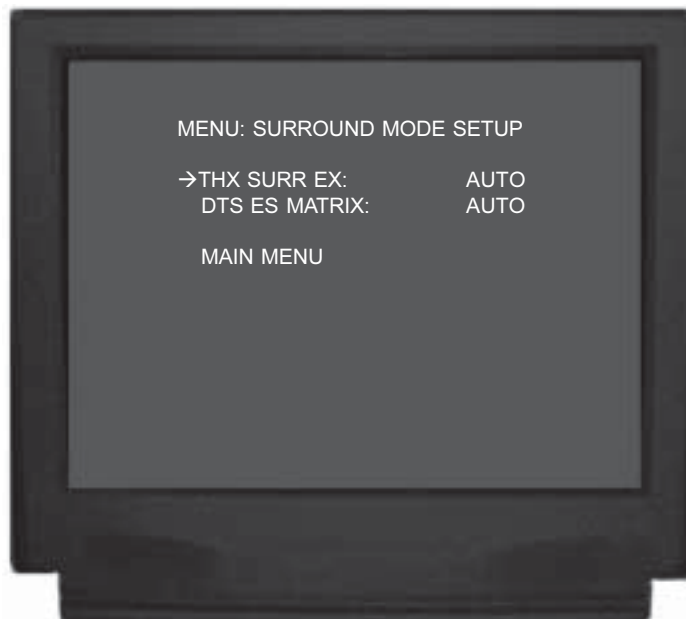

Figure 26

How to Change the Zone B Setup

The MX134 allows setting the wakeup Volume Level for Zone B. The level is expressed in percentage of maximum available volume.

1. Press and hold the Front Panel SETUP Push-button approximately three seconds to enter the Setup Mode. The word SETUP will appear on the MX134 Front Panel Display and the MAIN SYSTEM SETUP Menu will appear on the Monitor/TV screen. Refer to figure 25 on page 36.
2. Using the Up▲ or Down▼ directional push-buttons on the Remote Control, select Zone B Setup on the On-Screen Menu, followed by the SELECT Push-button. Refer to figure 27.
3. Using the Up▲ or Down▼ directional push-buttons, select VOLUME from the On-Screen Menu, followed by pressing the Left◀ or Right▶ directional push-buttons to select the desired Volume Level.
4. Continue next to the ADVANCED Settings. If you do not wish to perform ADVANCED Settings at this time, select MAIN MENU from the menu. The MAIN SYSTEM SETUP Menu will reappear on the Monitor/TV screen and proceed to the next step.
5. Select EXIT from the MAIN SYSTEM SETUP Menu. If you are satisfied with the changes that you may have made, select YES to save those changes or NO not to save them. The MX134 will then return to normal operation. Refer to figure 7 on page 23.

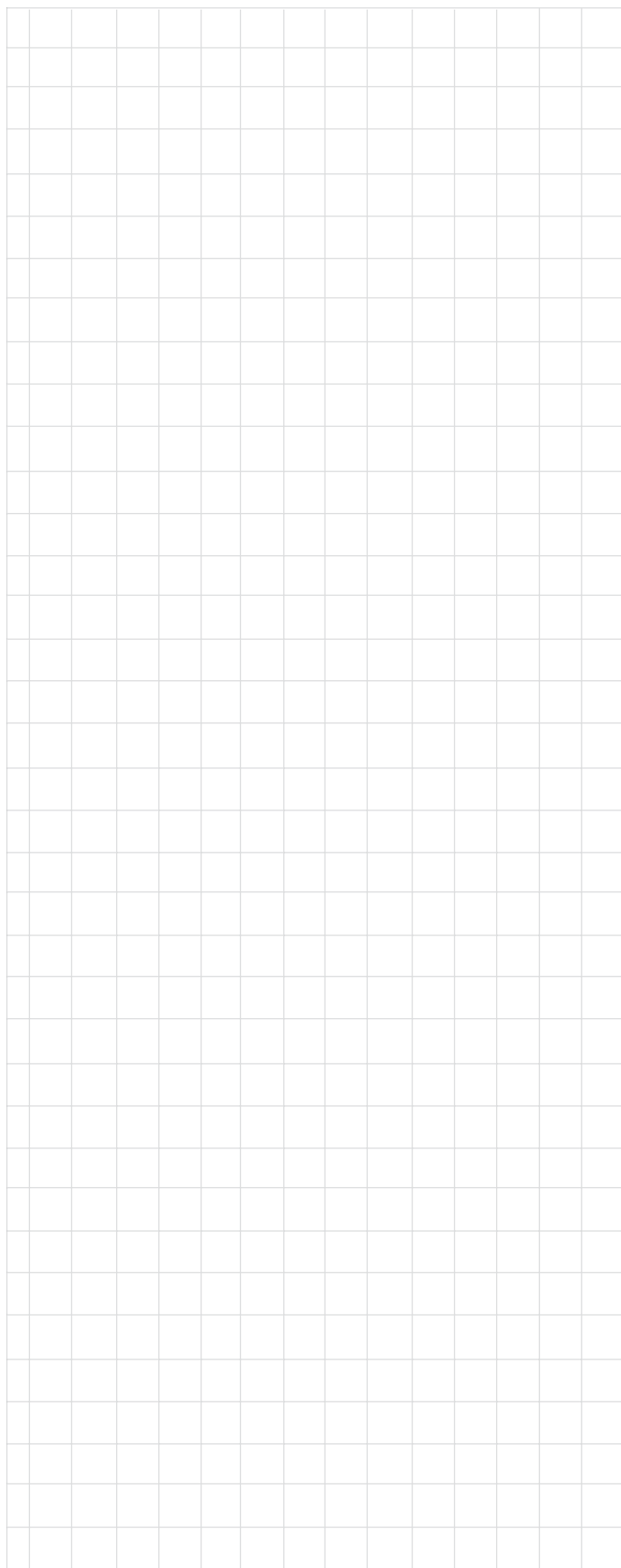

Figure 27

How to change the Advanced Settings

1. Press and hold the Front Panel SETUP Push-button approximately three seconds to enter the Setup Mode. The word SETUP will appear on the MX134 Front Panel Display and the MAIN SYSTEM SETUP Menu will appear on the Monitor/TV screen. Refer to figure 25 on page 36.
2. Using the Up▲ or Down▼ directional push-buttons on the Remote Control, select Advanced on the On-Screen Menu, followed by the SELECT Push-button. Refer to figure 27.
3. Using the Up▲ or Down▼ directional push-buttons, select DIGITAL SETTINGS from the On-Screen Menu.

Digital Lock

By default, the MX134 will automatically switch to and lock onto a Digital Signal. It will stay locked in Digital Mode even when there is a momentary interruption of the Digital Signal. An example of this could be when changing channels on a Digital Satellite Receiver. The Digital Lock Mode can be switched OFF to allow for 'on the fly' Digital/Analog Selection. To switch OFF the Digital Lock, perform the following steps. Refer to figure 29.

4. Using the Up▲ or Down▼ directional push-buttons, select DIGITAL LOCK from the On-Screen Menu, followed by pressing the Left◀ or Right▶ directional push-buttons to select OFF.
5. Continue next to the RC INPUT TOGGLE Settings. If you do not wish to perform RC INPUT TOGGLE Settings at this time, select the ADVANCED MENU followed by selecting MAIN MENU from the next menu. The MAIN SYSTEM SETUP Menu will reappear on the Monitor/TV screen and proceed to the next step.
6. Select EXIT from the MAIN SYSTEM SETUP Menu. If you are satisfied with the changes that you may have made, select YES to save those changes or NO not to save them. The MX134 will then return to normal operation. Refer to figure 7 on page 23.

RC Input Toggle

The MX134 incorporates Automatic Digital/Analog Audio Input Switching. When a source with an assigned digital input is selected, the MX134 will automatically search first for a Digital Audio Signal; if no Digital Signal is sensed, it switches to the Analog Signal. This RC Input Toggle feature can be manually overridden at any time by simply re-selecting that same source by pressing the appropriate Remote Control Push-button. To activate the RC Input Toggle perform the following steps:

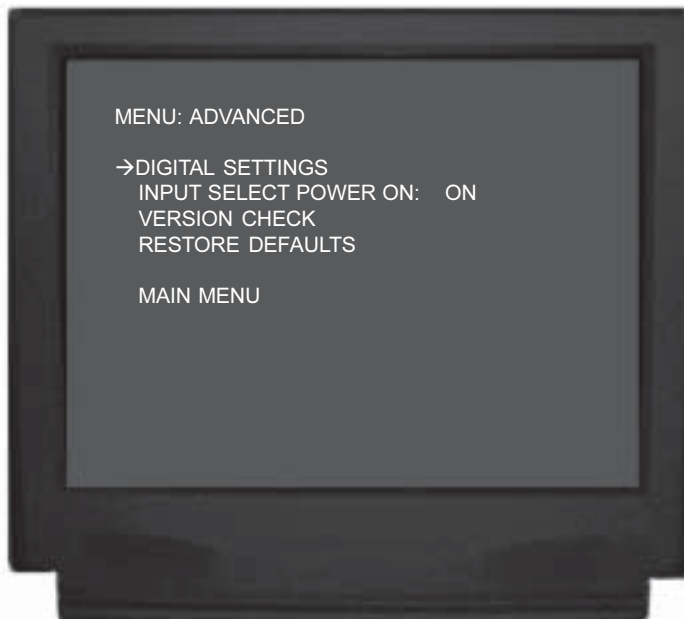

Figure 28

7. Using the Up▲ or Down▼ directional push-buttons, select RC INPUT TOGGLE from the On-Screen Menu, followed by pressing the Left◀ or Right▶ directional push-buttons to select On.
8. Using the Up▲ or Down▼ directional push-buttons, select ADVANCED MENU from the On-Screen Menu, followed by pressing the SELECT Push-button.
9. Continue next to the INPUT SELECT POWER ON Setting. If you do not wish to perform INPUT SELECT POWER ON Setting at this time, select the MAIN MENU. The MAIN SYSTEM SETUP Menu will reappear.



Figure 29

pear on the Monitor/TV screen and proceed to the next step.

10. Select EXIT from the MAIN SYSTEM SETUP Menu. If you are satisfied with the changes that you may have made, select YES to save those changes or NO not to save them. The MX134 will then return to normal operation. Refer to figure 7 on page 23.

Input Select Power On

The MX134 has a feature called Input Selector Power On that allows for easier operation. When an Input Source Push-button on the McIntosh Remote Control or Keypad is pressed, the MX134 will automatically turn-on from its Stand-by Mode without first having to press the Power Push-button. If you wish to de-activate this feature, perform the following. Refer to figure 28.

11. Using the Up▲ or Down▼ directional push-buttons, select INPUT SELECT POWER ON from the On-Screen Menu, followed by pressing the Left◀ or Right▶ directional push-buttons to select OFF.
12. Select the MAIN MENU. The MAIN SYSTEM SETUP Menu will reappear on the Monitor/TV screen and proceed to the next step.
13. Select EXIT from the MAIN SYSTEM SETUP Menu. If you are satisfied with the changes that you may have made, select YES to save those changes or NO not to save them. The MX134 will then return to normal operation. Refer to figure 7 on page 23.

Version Check

McIntosh makes different versions of the MX134 to meet the requirements in each country it is sold. The MX134 can display that version information by the following steps. Refer to figure 30.

14. Using the Up▲ or Down▼ directional push-buttons, select VERSION CHECK from the On-Screen Menu, followed by pressing the SELECT Push-button.
15. Press the SELECT Push-button to return to the ADVANCED Menu.
16. Select the MAIN MENU. The MAIN SYSTEM SETUP Menu will reappear on the Monitor/TV screen and proceed to the next step.
17. Select EXIT from the MAIN SYSTEM SETUP Menu. If you are satisfied with the changes that you may have made, select YES to save those changes or NO not to save them. The MX134 will then return to normal operation. Refer to figure 7 on page 23.



Figure 30

Restore Defaults

The MX134 permits returning all of the previously entered On-Screen Operating Settings back to the Factory Default Values by the following steps. Refer to figure 31.

Note: It is advisable to write down all current settings before proceeding, in the event you desire to re enter them later.

18. Using the Up▲ or Down▼ directional push-buttons, select RESTORE DEFAULTS from the On-Screen Menu, followed by pressing the SELECT Push-button.

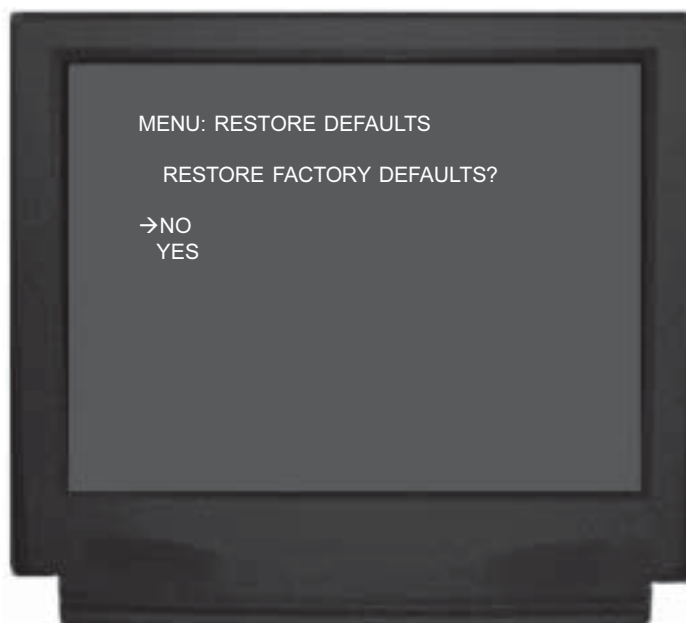
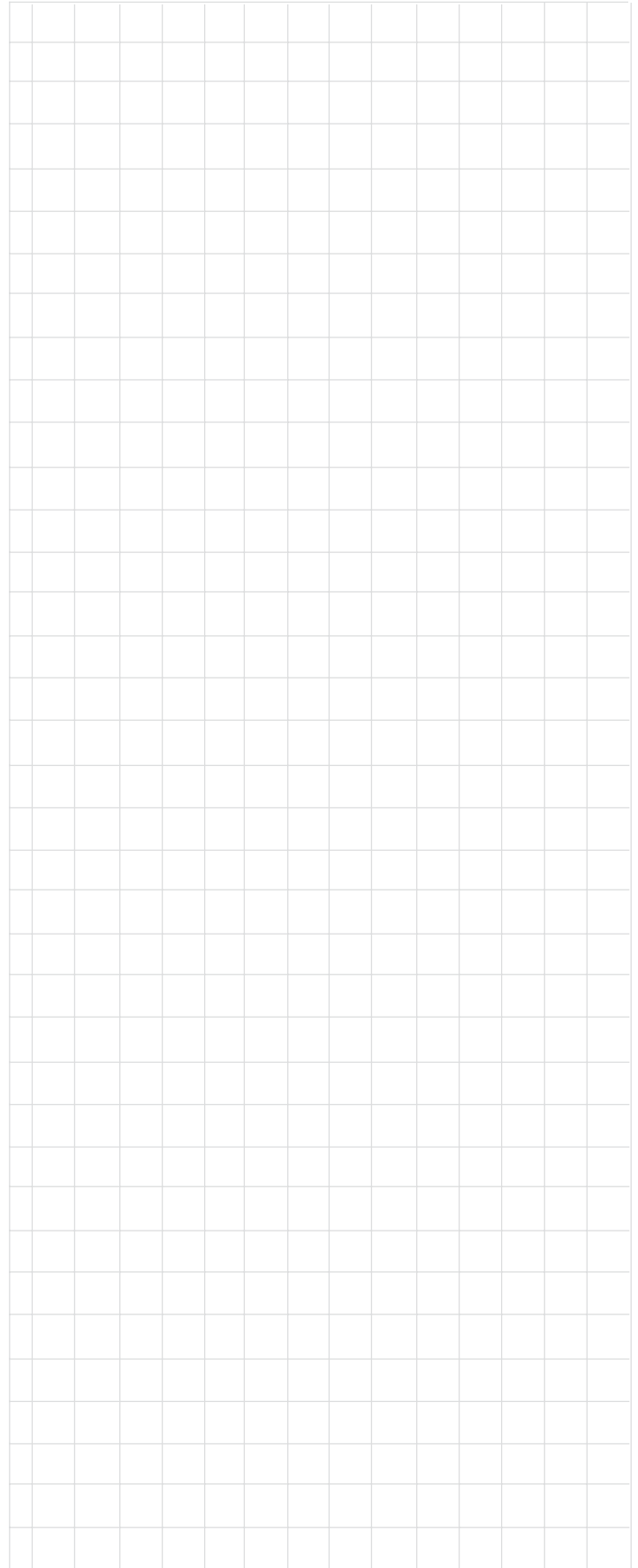

Figure 31

19. Using the Up▲ or Down▼ directional push-buttons, select YES from the On-Screen Menu, followed by pressing the SELECT Push-button. Refer to figure 32.
20. The On-Screen Menu will give you a second chance before the MX134 will be returned to the Factory Default Settings. Using the Up▲ or Down▼ directional push-buttons, select YES from the On-Screen Menu, followed by pressing the SELECT Push-button.
21. Select the MAIN MENU. The MAIN SYSTEM SETUP Menu will reappear on the Monitor/TV screen, proceed to the next step.
22. Select EXIT from the MAIN SYSTEM SETUP Menu. If you are satisfied with the changes that you may have made, select YES to save those changes or NO not to save them. The MX134 will then return to normal operation. Refer to figure 7 on page 23.
23. Switch the Main POWER Switch to the OFF Position.
24. Wait five minutes, then place the Main POWER Switch to the ON Position, then press the STANDBY Push-button.



Figure 32



How to Operate the MX134

The McIntosh MX134 has been factory configured for default operating settings that will allow immediate enjoyment of superb video and high fidelity audio without the need for further adjustments. If you wish to make changes to the factory default settings refer to the SETUP Section of this Owner's Manual.

Power On and Off

Press the POWER switch to ON, the Red LED above the STANDBY/ON Push-button lights to indicate the MX134 is in Standby Mode and the title MX-134 will appear on the Front Panel Alphanumeric Display for approximately two seconds. To Switch On the MX134 press the STANDBY/ON Push-button. The title MUTE will appear on the Front Panel Alphanumeric Display for approximately two seconds after Turn-On, with the Loudspeakers muted. Refer to figures 33, 34, 35 & 36.



Figure 33



Figure 34

Note: For normal operation, turn the MX134 On and Off with the Standby/On Push button. You may also turn On the MX134 by simply pressing the Power Push button on the Remote Control. If the A/V System Controller is not going to be used for an extended period of time, turn Off all AC Power with the Power Switch. If the MX134 is in the Stand by Mode and is

connected to a McIntosh Audio/Video Multizone Control System Controller, the Front Panel Alphanumeric Display will indicate REMOTE ZONE when any Zone of the Controller is switched On.

Input A and B Selector

The INPUT A Selector Switch selects the program signal source for Zone A. The selected source is indicated on the right side of the front panel display. INPUT B Selector Switch selects the program signal source for Zone B, the Tape Outputs and VCR outputs. The selected source is indicated on the left side of the Front Panel Display. Refer to figure 35.

Volume Control

Adjust the VOLUME Control to select the desired level in Zone A (Listen). The Volume control adjusts all eight channels simultaneously, and level is indicated from 0 to 99 in the



Figure 36



Figure 35

center of the front panel display. Zone B is not affected by the front panel VOLUME Control. Zone B (Record) volume level is adjusted only in Zone B with a Remote Control or Keypad. Refer to figure 36.

System Off

Normally, Remote Zones are turned On and Off individually in each respective zone by pressing the Power Push-button on a Keypad or Remote Control. If you desire to switch Off all zones of an entire McIntosh System simultaneously, including a control center and accessory source components, you can press the SYS OFF Push-button on the MX134 Front Panel. Refer to figure 36.

Note: The Sys Off Push button on a Keypad or Remote Control may also be used to switch Off the entire system.

Record Lock

The REcORD LOCK Push-button allows for disabling of the INPUT B (record, Zone B) Selector Switch while a recording is in process.

Setup

Pressing the SETUP Push-button activates the MX134 SETUP Mode for making changes to the Home Theater System.

Tuning ▼ ▲

The TUNING Up ▲ and Down ▼ Push-buttons allow for tuning to the next FM or AM Radio Station when the optional TM1 Tuner Module is installed.

Select

When the MX134 has the optional TM1 Tuner Module in-

stalled, the SELECT Push-button allows for selecting either the FM or AM Broadcast Bands.

Enter

When the MX134 has the optional TM1 Tuner Module installed, the ENTER Push-button is used for entering an AM or FM Broadcast into memory.

Preset ◀ ▶

The PRESET Left ◀ and Right ▶ Push-buttons allow for selecting the next FM or AM Radio Station that has been stored into memory, when the optional TM1 Tuner Module is installed.

Back Channel Mode

The BACK CHANNEL MODE Push-button on the Front Panel of the MX134 permits the temporary override of the MX134 Setup Menu Surround Mode Setting. The Back Channel Surround Processing may be switched On or Off, when the SURROUND MODE Selector is set to the THX CINEMA position. After the MX134 is placed into standby and switched back On, the status of the Back Surround Loudspeakers will revert to the Setup Menu Surround Mode Setting. Refer to figures 37, 38 and 39.



Figure 37

Note: The Surround Mode THX and/or DTS Menu Settings in the MX134 SETUP need to be set to either On or Auto in order to reproduce the Back Channel Surround Information. If the incoming Digital Signal contains a DTS Discrete ES Sound Track, the MX134 will automatically switch On the Back Surround Channels regardless of the BACK CHANNEL MODE Selection of On or Off.



Figure 36



Figure 38



Figure 39

Late Night

The LATE NIGHT Push-button turns a volume compression circuit On and Off. This feature suppresses loud sounds or music that might disturb neighbors or others not in the immediate area of the Home Theater. Soft levels are also raised slightly so they are still listenable at reduced overall volume levels. This works only on a Dolby Digital Sound Track with encoded data that supports the compression function. Refer to figure 36.

Reset of Microprocessors

In the event that the controls of the MX134 stop functioning, there is a user reset function built in. Press the POWER Switch to OFF and wait for two minutes. Then Press the POWER Switch to ON. This will reset the MX134 microprocessors. Refer to figure 36.

Note: The above condition is usually caused by either interruptions in AC power and/or major changes in voltage.

Front Panel Status

The three sets of front panel LEDs indicate the status of Input Format, Operating/Decoding Modes and the Output Format. Refer to figure 36.

Note: If a Digital Input is selected and the Digital Source Component is not producing an output signal, none of the Front Panel Status LEDs will illuminate.

Input Format

- A. If the input signal source is Eight Channel Discrete, the front panel INPUT FORMAT LEDs L, C, R, LFE, LS, S and RS will illuminate. Refer to figure 40.
- B. If a Digital Input Signal Source is 2 Channel Surround Encoded, the front panel INPUT FORMAT LEDs L, R and S will illuminate.



Figure 40

Note: This will only occur when the SURROUND MODE is in CINEMA or THX CINEMA.

- C. If the Analog Input Signal Source is Stereo, the INPUT FORMAT LEDs L and R will illuminate.
- D. If an Analog Input Signal Source is Mono, both channels will be receiving the mono signal and the INPUT FORMAT LEDs L and R will illuminate.

Operating Mode Displays

- E. The DTS Display will illuminate when the input contains DTS Encoded Signals. Refer to figure 41.
- F. The PRO LOGIC II Display will illuminate when the Surround Mode Selector is turned to CINEMA or THX CINEMA and the Input Signal is Dolby Surround Encoded.
- G. The DOLBY DIGITAL Display will illuminate when the input contains Dolby Digital Encoded Signals.
- H. The THX REF (Reference) Display will illuminate when the Volume control is set to the THX level. The THX default volume level is 65%, but it will change if levels are adjusted up or down in the SPEAKER LEVEL Setup.



Figure 41

Note: The THX Volume Sound Level will be loud with most Home Theater Systems.

Output Format:

- I. The OUTPUT FORMAT LEDs indicate the SURROUND MODE selected and the active audio channels. Refer to figure 42.
- J. MUSIC 1, 2, 3, CINEMA, THX CINEMA and EXTERNAL will cause the L, C, R, SUB, LS and RS to illuminate.
- K. STEREO mode will cause the L, R and SUB LEDs to illuminate.
- L. MONO will cause the C and SUB LEDs to illuminate.
- M. The Back Surround On mode will cause the BS LED to illuminate.



Figure 42

Note: If the Subwoofer is set to OFF in the Speaker Size Setup, the SUB LED will not illuminate.

How to Operate the Trim Mode

The MX134 TRIM SELECT Switch together with the TRIM LEVEL Control provide the means for adjusting seven different audio functions and the Front Panel Alpha-numeric Display Brightness. This can be accomplished from either the Front Panel Controls or with the supplied Remote Control very conveniently from the Listening/ Viewing Area. The Front Panel Alphanumeric Display indicates the Trim Mode Selected and Trim Levels. You can create the sound quality that you prefer while listening to music or a movie sound track. Refer to figures 43 & 45.

Note: The following Trim Instructions refer only to Trim Setting Examples performed using the Remote Control. Make any Trim Adjustments based on your own preferences.

Loudspeaker Volume Levels

The Volume Levels of the Center, Subwoofer and Surround Loudspeakers can be adjusted up or down by 12dB relative to the Left and Right Front Loudspeakers. Trim Levels can be adjusted separately for Surround Modes of STEREO, MUSIC 1, 2 and 3, EXTERNAL and MONO and saved in permanent memory. Any Surround Trim level adjustments made in CINEMA and THX CINEMA will revert back to the Setup Loudspeaker Levels when the MX134 is switched Off.

1. Press and release the TRIM Push-button on the Remote Control until SUB TRIM appears on the Front Panel Display. Refer to figure 43.

Notes: 1. You can also perform all TRIM functions using the Front Panel TRIM SELECT and TRIM LEVEL controls.



Figure 43



Figure 44

2. *Low Frequency Information must be present in the Program Source Material in order to hear any changes in the Subwoofer Loudspeaker Levels.*

2. Press the LEVEL Up▲ Push-button until the number 5 appears to the right of SUB TRIM on the Front Panel Display. This is an example of increasing the Subwoofer level by 5dB.
3. Press and release the TRIM Push-button until SURR TRIM appears on the front panel display. Refer to figure 46.



Figure 45



Figure 46

4. Press the LEVEL Down▼ Push-button until the number -10 appears to the right of SURR TRIM on the front panel display. This is an example of decreasing the Surround Loudspeakers Levels by 10dB.
5. Press and release the TRIM Push-button until CTR TRIM appears on the front panel display. Refer to figure 47.



Figure 47

6. Press and release LEVEL Up▲ Push-button until the number 3 appears to the right of CTR TRIM on the front panel display. This is an example of increasing the Center Loudspeaker Level by 3dB.

Note: 1. If no Trim adjustments are changed for ten seconds, the TRIM Mode will be cancelled and the normal front panel display will appear. To exit quickly from the TRIM Mode, press and release the TRIM Push button until TRIM OFF appears on the display. After five seconds, the

Front Panel Alphanumeric Display will return to normal.

2. The location of the Trim Selector Control will remain in the last selected position until the INPUT A Signal Source or Surround Mode is changed.

Bass, Treble and Loudness Compensation

The MX134 allows for changing the tonal response for any of the eleven inputs via the BASS, TREBLE and LOUDNESS Compensation TRIM Adjustments. Any tonal changes made are saved in permanent memory and automatically recalled any time that particular input is selected again. The Bass and Treble Tonal Response can be adjusted up or down by 12db from the Flat Setting.

The Loudness Control Function automatically increases bass response as the volume level is lowered for improved listening at softer volume levels. The amount of Loudness Boost is adjustable in 10% increments from 10% to 100%. The maximum Loudness boost is 18dB, less any bass boost that may have been previously set by the Bass Trim function. For example if the Bass is boosted 10dB, the maximum additional Loudness boost will be 18dB less 10dB or 8dB.

Note: If tonal adjustments are performed on an input when the Surround Mode is set to the THX CINEMA, a flat tonal response will be reset for that input when the MX134 is switched Off.

1. Press and release the TRIM Push-button until BASS TRIM appears on the Front Panel Alphanumeric Display. Refer to figure 48.



Figure 48

2. Press and release the LEVEL Up▲ Push-button until the number 10 appears to the right of BASS TRIM on the Front Panel Alphanumeric Display. This is an example of increasing the Bass response by 10dB.
3. Press and release the TRIM Push-button until TREB TRIM appears on the Front Panel Alphanumeric Display. Refer to figure 49.



Figure 49

4. Press and release the LEVEL Up▲ Push-button until the number 11 appears to the right of TREB on the Front Panel Alphanumeric Display. This is an example of increasing the Treble response by 11dB.
5. Press the TRIM Push-button until TRIMLOUD appears on the Front Panel Alphanumeric Display. Refer to figure 50.



Figure 50

6. Press a LEVEL Up▲ or Down▼ Push-button until the desired percent of Loudness is indicated to the right of TRIMLOUD on the Front Panel Alphanumeric Display.

Display Brightness

The MX134 Trim feature allows adjustments to the brightness of the Front Panel Alphanumeric Display to the desired intensity. The Display Trim brightness range extends from Off to a maximum of 31.

Note: You may find it easiest to make Display adjustments with the Front Panel Controls.

1. Press and release the TRIM Push-button, or turn the TRIM SELECT Control, until DISPLAY appears on the Front Panel Alphanumeric Display. A number to the right of the display indicates the current brightness level. Refer to figure 51.



Figure 51

2. Press a LEVEL Up▲ or Down▼ Push-button, or turn the TRIM LEVEL Control, until you reach the desired display brightness.

How to Operate the Surround Mode

The MX134 provides eight different Surround Modes. The Front Panel Alphanumeric Display and the Output Format LEDs will indicate the Surround Mode selected. The Surround Mode Selected is stored into permanent memory and automatically recalled any time that particular input is selected again. If the Surround Mode is changed when the input is again selected, the new mode will be active and stored. Refer to figure 52.

Note: The Remote Control may also be used to make changes

to the Surround Modes. Refer to figure 53.



Figure 52

Stereo Mode

A Stereo signal source connected to an Analog Audio Input is reproduced without any processing. The Front Panel Alphanumeric Display will indicate PURE STEREO. When a Digital Audio Input is selected in stereo mode, the Front Panel Alphanumeric Display will indicate DSP STEREO. All multi-channel signal sources are combined and reduced to 2 channels in the stereo mode. The Output Format LEDs L, R and SUB will illuminate. Refer to figures 54, 55 and 56.

Note: If the Subwoofer was turned OFF in the SPEAKER SIZE setup, the OUTPUT FORMAT SUB LED will not illuminate.



Figure 54



Figure 53



Figure 55



Figure 56

Music 3

The ambience present in Stereo Recorded Music is reinforced by Digital Signal Processing using Dolby Pro Logic II Circuitry. The Left and Right Difference Signal is sent to the Left and Right Surround Loudspeakers. The Left and Right Stereo signals are combined and sent to the Center Loudspeaker. The Front Panel Alphanumeric Display will indicate MUSIC 3. The Output Format LEDs L, C, R, LS, RS and SUB will illuminate. The PRO LOGIC II Display will also illuminate. Refer to figures 57 and 58.



Figure 57



Figure 58

Music 2

This processing mode creates an effect similar to listening in a smaller room and will enhance pop and rock music. Left and Right Stereo signals are combined and sent to the Left and Right Surround Loudspeakers with a fast decay time. The combined Left and Right signals are also sent to the Center Loudspeaker. The Front Panel Alphanumeric Display will indicate MUSIC 2. The Output Format LEDs L, C, R, LS, RS and SUB will illuminate. Refer to figures 59 and 60.



Figure 59

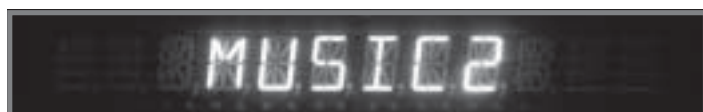

Figure 60

Music 1

This processing mode creates an effect similar to listening in a large room or an outdoor area. The Left and Right Stereo signals are combined and sent to the Left and Right Surround Loudspeakers with a long time delay. The combined Left and Right signals are also sent to the Center Loudspeaker. The Front Panel Alphanumeric Display will indicate MUSIC 1. The Output Format LEDs L, C, R, LS, RS and SUB will illuminate. Refer to figures 61 and figure 62.



Figure 61



Figure 62

Cinema

This provides decoding of Dolby Pro Logic II channel Analog or Digital signals and decoding of Dolby Digital signals or DTS signals. The Front Panel Alphanumeric Display will indicate CINEMA. The Output Format LEDs L, C, R, LS, RS and SUB will illuminate. Refer to figures 63 and 64.



Figure 63



Figure 64

THX Cinema

THX signal processing is active in this mode, and is best for reproducing a film sound track that was originally created for use in a movie theater. THX Adaptive Decorrelation, Re-EQ Filtering and Timbre Match are added to the Pro Logic, Dolby Digital and DTS Decoded Signals. The Front Panel Alphanumeric Display will indicate THX CINEMA. The Output Format LEDs L, C, R, LS, RS and SUB will illuminate. Refer to figures 65 and 66.



Figure 65

Note: If the Back Channel Surround Mode is set to On or Auto in the MX134 Surround Mode Setup the BS Output Format LED may also illuminate.



Figure 66

External

All internal signal processing is bypassed and the eight Rear Panel EXTERNAL INPUTS are activated so the MX134 performs as an Eight Channel Preamplifier for an external source or processor. The Front Panel Alphanumeric Display indicates EXTERNAL and the OUTPUT FORMAT LEDs L, C, R, LS, RS, BS and SUB will illuminate. Refer to figures 67 and 68.



Figure 67

Note: Approximately 3 seconds after selecting EXTERNAL SURROUND MODE, the Front Panel Alphanumeric Display will change indicating EXTERNAL to the normal display of INPUT A, INPUT B and percentage of VOLUME.



Figure 68

Mono

All Mono Signals are sent only to the CENTER Loudspeaker and the Front Panel Alphanumeric Display will indicate MONO. All Multi-channel Signal Sources are combined to a single channel for Mono. The OUTPUT FORMAT LEDs C and SUB will illuminate. Refer to figures 69 and 70.



Figure 69

Note: If the Subwoofer was turned OFF in the SPEAKER SIZE setup, the OUTPUT FORMAT SUB LED will not illuminate.



Figure 70

How To Make A Tape Recording

The separate INPUT B (Record) and INPUT A (Listen) Switches allow for the making of a recording from one program source while listening to another. You can also listen (monitor) to the recorded signal off the tape, a fraction of a second later, during recording when a three head tape recorder is used. Refer to figure 71.

1. Select the desired program source to record with the front panel INPUT B RECORD selector switch.
2. Press the REC LOCK (Record Lock) Push-button to disable any Zone B sensors or Keypads to avoid a Zone B selection interfering with the recording process.
3. Adjust the record level using the tape recorder volume control.
4. To monitor the tape during recording with a three head tape recorder, or playback the tape just recorded, turn the INPUT A LISTEN switch to select the recorder used to make the tape.

Note: The MX134 RECORD OUTPUTS are not affected by the VOLUME control. To listen to a different program source while recording, turn the LISTEN switch to the desired source. The recording process will not be affected and will continue.



Figure 71

How to Operate Zone B

The MX134 includes the feature of being able to operate and control two Audio/Video Zones, independent of each other. Zone A is designed to be the Primary (Home Theater Listening Area) with Surround Sound capability. Zone B is configured for a Secondary Remote Location providing two channel audio and video programs.

The program source selected for Zone A appears on the right side of the MX134 Front Panel Alphanumeric Display, and the program source selected for Zone B appears on the left side. Zone A Sources are selected by using the INPUT A (Listen) Selector Switch and the Zone B Sources are selected by using the INPUT B (Record) Selector Switch. Refer to figure 72.



Figure 72

1. Zone B may be switched On or Off by pressing the POWER Push-button on the Keypad or using a Remote Control aimed at a Sensor located in Zone B. When Zone B is switched On the MX134 Front Panel Display will indicate ZONE B ON if Zone A is not active. Refer to figures 73, 74 and 75.

Note: Zones A and B may be Turned Off by pressing the SYS Push button on the Front Panel, Keypad or using the Remote Control. Refer to figures 71, 73 and 74. Source selection may also be accomplished from the MX134 Front Panel INPUT B (Record) Selector.



Figure 73



Figure 74

- 2. Select the desired Zone B Source and adjust the Volume to the desired listening level by pressing the appropriate push-buttons on the Keypad or Remote Control. Refer to figure 74 and 75.

Note: The audio may be muted at any time by pressing the Mute Push button on the Keypad or Remote Control.

- 3. If a McIntosh Disc Player is connected to the MX134, most operating functions can be performed with the Keypad or Remote Control.

Rec Lock

The RECOrd LOCK Push-button on the Front Panel of the MX134 prevents the changing of the Inputs via the INPUT B (Record, Zone B) Selector, Keypad and Remote Control Input Push-buttons.



Figure 75

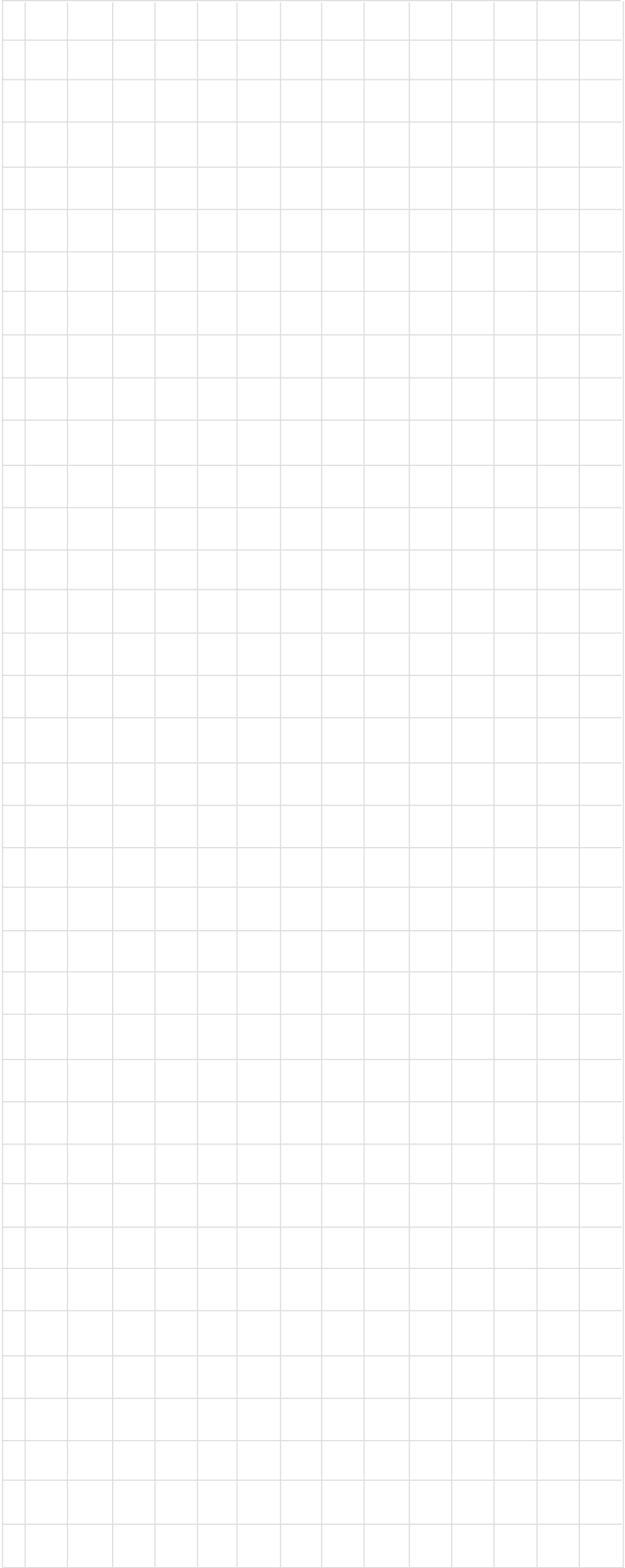

Audio Specifications

Frequency Response

STEREO Left and Right Small speakers:
80Hz-20,000Hz
Subwoofer:
20Hz-80Hz

Left and Right Large speakers:
20Hz-20,000Hz
Subwoofer:
OFF

PRO LOGIC II Left, Center, Right, Small speakers:
Movie 80Hz-20,000Hz
Processing Surround Small speakers:
Mode 80Hz-7kHz
Subwoofer:
20Hz-80Hz

PRO LOGIC II Left, Center, Right, Large speakers:
Music 20Hz-20,000Hz
Processing Surround Large speakers:
Mode 20Hz-20,000Hz
Subwoofer:
OFF

DOLBY Left, Center, Right Small speakers:
DIGITAL 80Hz-20,000Hz
and DTS Surround Small speakers:
80Hz-20,000Hz
Subwoofer:
20Hz-80Hz

Left, Center, Right Large speakers:
20Hz-20,000Hz
Surround Large speakers:
20Hz-20,000Hz
Subwoofer:
20Hz-80Hz

EXTERNAL Left, Center, Right, Left Surround,
INPUT Right Surround:
20Hz-20,000Hz
Subwoofer:
20Hz-120Hz

Rated Output

All Modes: 2.0Vrms for full bit digital input

Input Impedance

22K ohms

Output Impedance

47 ohms at all outputs

Maximum Output Voltage

9.5Vrms

Total Harmonic Distortion

0.005% at all outputs

Sensitivity

Analog Input: 400mV for 2.0V output

Signal To Noise Ratio - All Outputs

Greater than 90dB un-weighted
Greater than 100dB A weighted
Greater than 98dB CCIR

Maximum Input Signal

Analog Input: 6Vrms

Voltage Gain

Analog Input to Output: 14dB

Frequency Response

+0, -0.5dB from 20Hz to 20,000Hz

Tone Controls

+12dB, -12dB from flat setting

General Specifications

Power Requirements

100 Volts, 50/60Hz at 65 watts
110 Volts, 50/60Hz at 65 watts
120 Volts, 50/60Hz at 65 watts
220 Volts, 50/60Hz at 65 watts
230 Volts, 50/60Hz at 65 watts
240 Volts, 50/60Hz at 65 watts

Note: Refer to the rear panel of the MX134 for the correct voltage.

Overall Dimensions

Front Panel: 17-1/2 inches (44.5cm) wide, 7-5/8 inches (19.37cm) high. Depth behind front mounting panel is 21 inches (53.3cm) including clearance for connectors. Panel clearance required in front of mounting panel is 1-1/8 inches (2.9cm).

Weight

32.5 pounds (14.8Kg) net, 51.5 pounds (23.4Kg) shipping

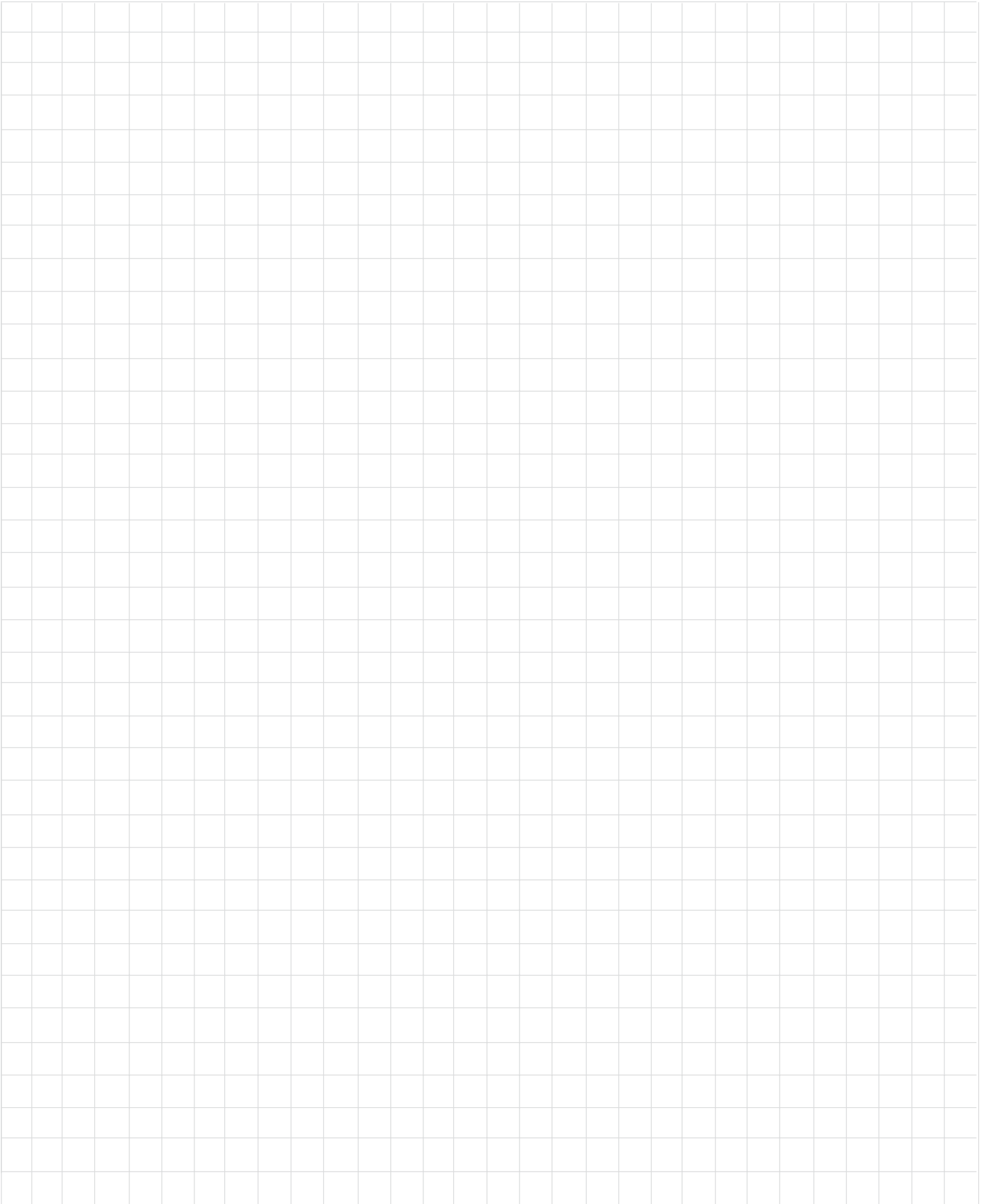

TM1 AM/FM Tuner Module

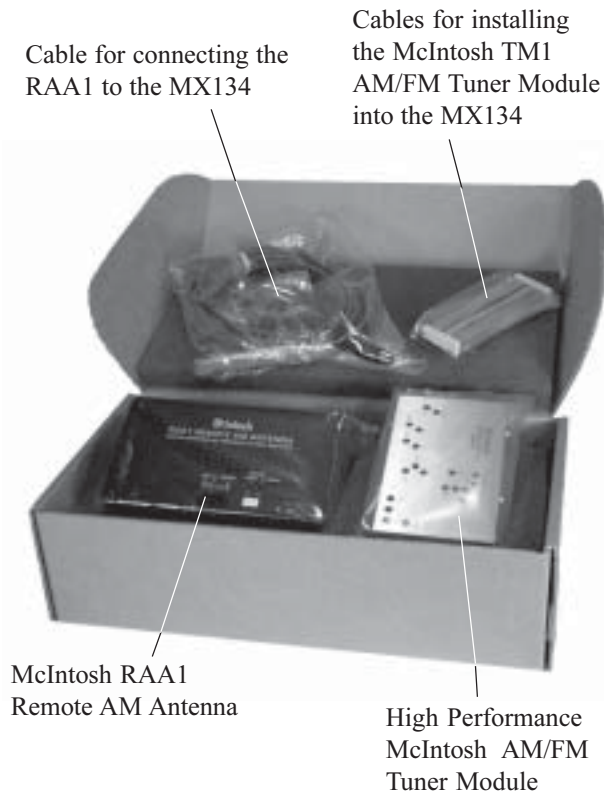

Introduction

The MX134 A/V Control Center has provisions for adding an optional McIntosh TM1 AM/FM Tuner Module for Radio Station Reception. The TM1 delivers the same exceptional performance as the stand-alone McIntosh MR85 Tuner. The TM1 is available from your McIntosh Dealer and can be installed at any time, usually while you wait.

Performance Features

- **Special FM RF Amplifier**

Double-Diffused Metal Oxide Field Effect Transistor (DMOS-FET) RF amplifier increases sensitivity and Cross Modulation rejection.

- **External AM RF Amplifier and Antenna**

The TM1 includes a RAA1 Remote AM Antenna that contains an electrostatically shielded AM RF Amplifier Stage for maximum noise rejection. It can be located in a remote area, away from sources of interference and can be positioned for the best possible reception of even the weakest AM stations.

- **FM Stereo Auto Blend Circuitry**

An automatic variable stereo separation control circuit is used to reduce background noise when receiving weak stereo stations.

- **Preset Stations and Permanent Memory**

Nine AM and nine FM station presets make it easy to listen to your favorite stations. Station Presets and Functions Modes are retained in Permanent Memory even when AC power is switched Off.

- **Alphanumeric Fluorescent Display**

The MX134 Multi-function Front Panel Display indicates station frequency, station preset number, signal strength, stereo and broadcast band.

TM1 Table of Contents

Introduction	52
Performance Features	52
MX134 Rear and RAA1 Top Panels	
Antenna Connections	53
How to Connect Antenna Components	54
How to Operate the Tuner	55
How to Assign Preset Stations	56
How to Optimize AM Reception	57
FM Specifications	58
AM Specifications	58

MX134 Rear Panel and RAA1 Top Panel Antenna Connections

RAA1 Remote Antenna can be adjusted to a position for optimum reception of your favorite AM stations

Connects with supplied cable to the MX134



AM ANT (Antenna) connector allows a McIntosh Remote Antenna to be connected

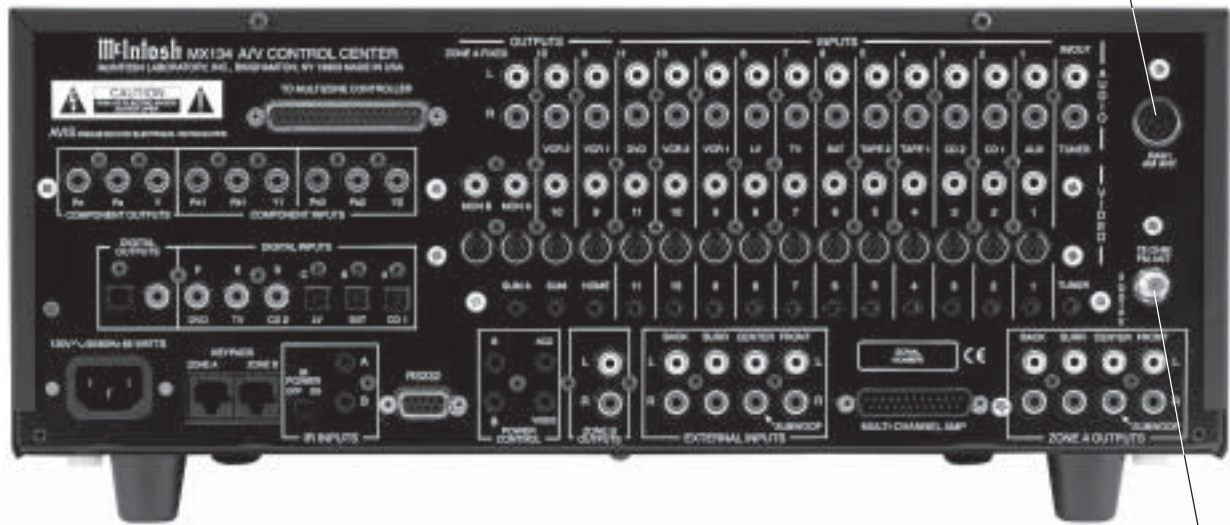

75 OHM FM ANT (Antenna) connects to an external FM Antenna or cable

*Note: Proceed to page 13
and start the
connection process.*

How to Connect Antenna Components

1. Connect the Remote AM Antenna by plugging the DIN Connector of the supplied 3 conductor cable into the AM ANTenna, DIN socket on the back panel of the MX134.

Note: If a longer length cable needs to be used between the MX134 and the RAA1, use a 2 conductor shielded cable.

2. Connect a 75 ohm coax cable from an FM Antenna or cable system to the MX134, 75 OHM FM ANTenna Connector.
3. Proceed to page 16 and continue the connection process.

RAA1 Connector

Connect the shield and two leads of a shielded 2 conductor cable to the supplied 5 Pin Terminal Connector Plug. Refer to the connection information on the top cover of the RAA1.

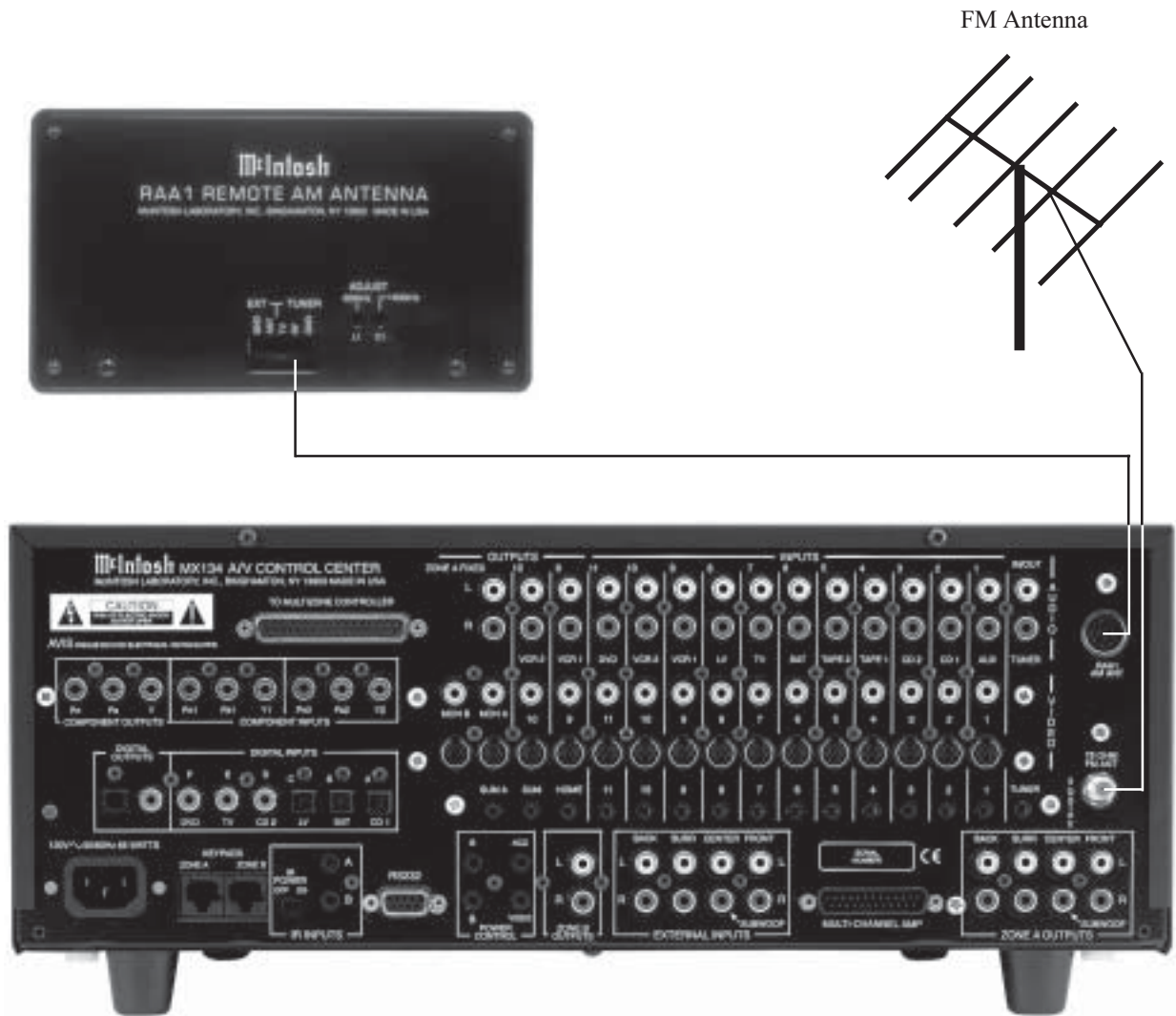
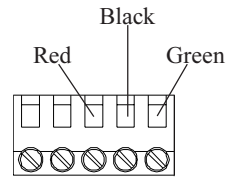

How to Tune Stations Manually

The McIntosh MX134 TM1 AM/FM Tuner Module incorporates an advanced design AM/FM Tuner with many desirable performance features to enhance your enjoyment of radio broadcasts. There are four methods of tuning to an AM/FM Broadcast Station. These are Manual, Automatic Preset Review, Preset Push-button Search and Direct Preset Number Access using the Remote Control.

1. Select TUNER with the Front Panel INPUT A (Listen) Switch or the Remote Control TUNER Push-button. Refer to figures 78 & 79.
2. Press the SELECT Push-button on the Front Panel until the desired AM or FM Broadcast Band is selected.
Note: When using the Remote Control press either the FM or AM Push button to select the desired Broadcast Band.
3. Press the Front Panel TUNING Up▲ or Down▼ Push-button, or the CHANNEL Up▲ or Down▼ Push-button on the Remote Control, to select stations. Press and release the TUNING (CHANNEL) Push-buttons to move from one station to the next. Press and hold to

move continuously up or down the broadcast band. When a station is selected, the Front Panel Alphanumeric Display will indicate (from left to right) Station Signal Strength from 1 to 9, a dot if the Broadcast is Stereo, the AM or FM Station Frequency, AM or FM Broadcast Band and a Preset Number (if that station has been assigned a Preset). Refer to figures 76 and 77.

Notes: FM Broadcast Band Indications are in Megahertz in the US and Canada, and change frequency in 200kHz steps. The second digit to the right of the dot which displays a 0, is used for FM stations in various locations other than the US where stations change in 50kHz steps. AM Broadcast Band Indications are in Kilohertz and change frequency in 10kHz steps.



Figure 76



Figure 77



Figure 79



Figure 78

How to Assign Preset Stations

The MX134 AM/FM Tuner Module (TM1) allows for pre-setting radio stations into memory. To enter Presets follow the below steps:

Note: If there are no Presets Assigned and either the Front Panel PRESET Push buttons or the Remote Control REVIEW Push button are pressed, the MX134 Front Panel Alphanumeric Display will indicate NO PRESETS. Refer to figure 80.



Figure 80

1. Select either the AM or FM Broadcast Band.
2. Press the Front Panel TUNING Up▲ or Down▼ Push-button, or the CHANNEL Up▲ or Down▼ Push-button on the Remote Control, to select a station.
3. Momentarily press and release the Front Panel ENTER Push-button. The Front Panel Alphanumeric Display will indicate 1 AVAILABLE, which is the first of 9 Preset Numbers that can be assigned. The Station that is about to be entered into memory may also be assigned to a different Preset Number (2-9) by pressing the PRESET Left◀ and Right▶ Push-buttons to select the desired Preset Number.

Note: Presets are automatically assigned in order from 1 to 9 unless a different Preset Number is selected

4. Press and release the Front Panel ENTER Push-button a second time to store the Preset into memory. The just entered Station Preset Selection will be assigned Preset Number 1 which is displayed on the far right side of the Front Panel Alphanumeric. Refer to figures 81 and 82.



Figure 81



Figure 82

5. Assign additional station Presets by performing steps 1 through 5 until a total of 9 AM and 9 FM Station Presets have been assigned. Each time you assign an additional Preset Number, the Front Panel Alphanumeric

Display will indicate the number of the next available Preset.

Note: If all 9 Presets are assigned and the ENTER Push button is pressed, the display will indicate the station selected for Preset Number 1.

6. To verify the Station Preset(s) just entered into memory, press the PRESET Left◀ and Right▶ Push-buttons to cycle through and confirm your preset assignments.

Note: Pressing the REVIEW Push button on the Remote Control will also allow reviewing the stored Presets.

How To Clear an Assigned Station Preset

1. Press ENTER Push-button.
2. Press the Front Panel PRESET Left◀ and Right▶ Push-buttons to select the Preset Station that will be removed from memory.
3. Press and Hold the ENTER Push-button for approximately 3 seconds until the Front Panel Alphanumeric Display indicates the word CLEARED. Refer to figure 83.

Note: If you wish to replace an already assigned Station Preset with another radio station, it is not necessary to clear the Preset first, just enter in the new station for that Preset. The new station will automatically replace the previously assigned station.



Figure 83

4. To clear any additional Station Presets perform steps 1 through 3 again.

How to Optimize AM Reception

The McIntosh RAA1 Remote AM Antenna is designed to provide the best in AM Reception especially if the tuner or A/V unit is located in a noisy reception area. Locate the RAA1 away from all electronic and electrical interference sources. Rotate the AM Antenna to reduce interference and receive maximum signal strength.

Notes: The RAA1 Remote AM Antenna of the TMI has been factory adjusted for optimum reception in a typical urban location. If you wish to customize the AM Antenna for the best possible performance in your location, have your dealer perform the two adjustment operations listed below.

An additional long wire AM antenna or external ground can be connected to the GND and ANT terminals if desired.



Figure 84

1. Tune to a weak AM station near 600kHz on the AM band. Using an appropriate NON -

METALLIC tool, adjust the 600kHz Transformer L1 for maximum signal strength. Refer to figure 84.

2. Tune to a weak AM station near 1400kHz on the AM band. Using an appropriate **NON - METALLIC** tool, adjust the 1400kHz Trimmer Capacitor C1 for maximum signal strength.
3. Repeat steps 1 and 2 until no further improvements can be obtained.

FM and AM Station Presets				
Preset Number	Frequency	City	Call Letters	Name
FM 1				
FM 2				
FM 3				
FM 4				
FM 5				
FM 6				
FM 7				
FM 8				
FM 9				
AM 1				
AM 2				
AM 3				
AM 4				
AM 5				
AM 6				
AM 7				
AM 8				
AM 9				

FM Tuner Specifications

Useable Sensitivity

14dBf which is 1.4uV across 75 ohms

50dB Quieting Sensitivity

Mono: 19dBf which is 2.4uV across 75 ohms

Stereo: 35dBf which is 15uV across 75 ohms

Signal To Noise Ratio

Mono: 75dB

Stereo: 70dB

Frequency Response

Mono: + 0, - 1dB from 20 to 15,000Hz

Stereo: + 0, - 1dB from 20 to 15,000Hz

Harmonic Distortion

Mono: 0.3% at 100Hz

0.3% at 1,000Hz

0.3% at 10,000Hz

Stereo: 0.45% at 100Hz

0.45% at 1,000Hz

0.65% at 10,000Hz

Intermodulation Distortion

Mono 0.25%

Stereo 0.45%

Capture Ratio

1.2dB

Alternate Channel Selectivity

75dB

Spurious Response

100dB

Image Response

75dB

RF Intermodulation

65dB

Stereo Separation

45dB at 100Hz

45dB at 1,000Hz

35dB at 10,000Hz

SCA Rejection

65dB

AM Tuner Specifications

Sensitivity

20uV External Antenna Input

Signal To Noise Ratio

48dB at 30% modulation

58dB at 100% modulation

Harmonic Distortion

0.5% maximum at 50% modulation

Frequency Response

50Hz to 6kHz NRSC

Adjacent Channel Selectivity

45dB minimum IHF

Image Rejection

65dB minimum from 540 to 1600kHz

IF Rejection

80dB minimum

Packing Instructions

In the event it is necessary to repack the equipment for shipment, the equipment must be packed exactly as shown below. It is very important that the four plastic feet are attached to the bottom of the equipment. This will ensure the proper equipment location on the bottom pad. Failure to do this will result in shipping damage.

Use the original shipping carton and interior parts only if they are all in good serviceable condition. If a shipping carton or any of the interior part(s) are needed, please call or write Customer Service Department of McIntosh Laboratory. Please see the Part List for the correct part numbers.

Quantity	Part Number	Description
1	033888	Shipping carton only
4	033887	End cap
1	033697	Inside carton only
1	033725	Top pad
1	034194	Bottom pad
1	034037	Inner carton pad
4	017218	Plastic foot
4	100159	#10-32 x 3/4" screw
4	104083	#10-7/16" Flat washer

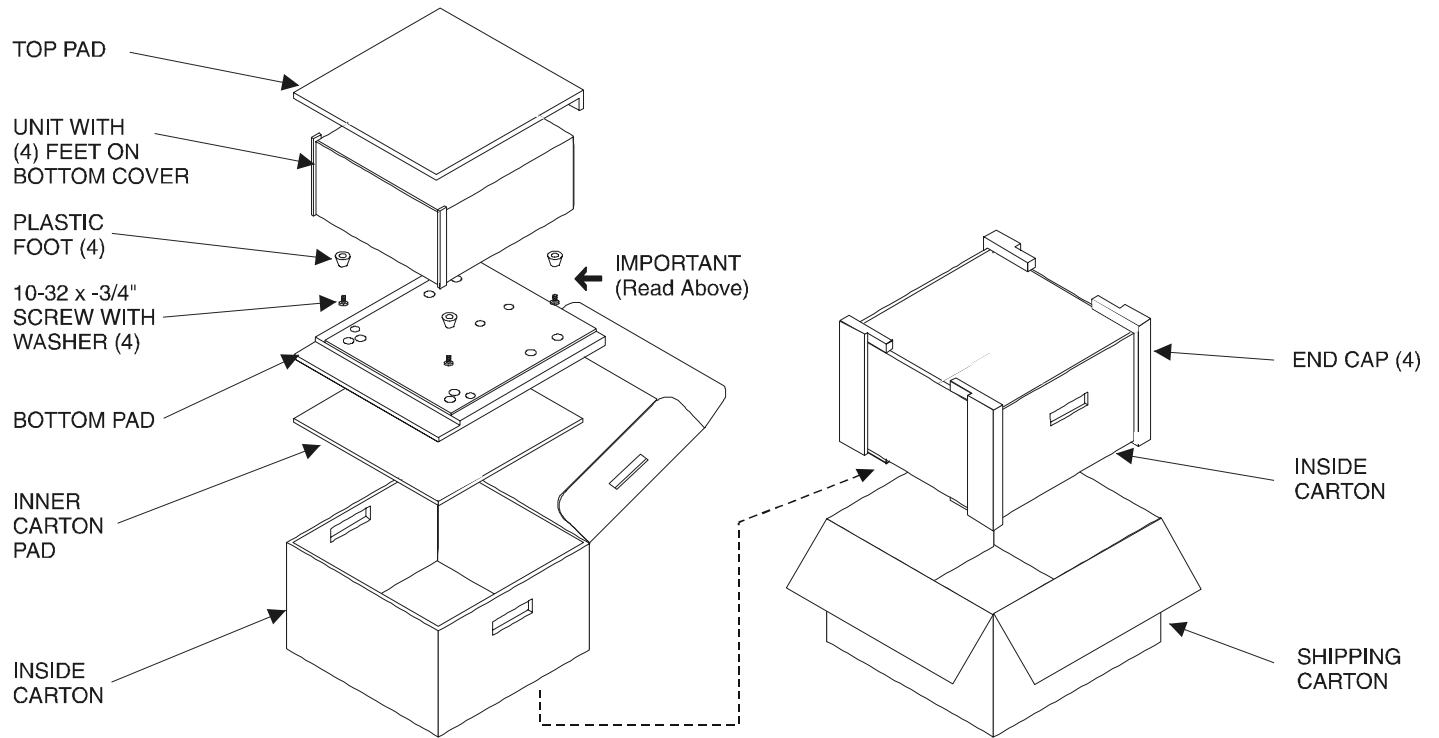

McIntosh[®]

McIntosh Laboratory, Inc.
2 Chambers Street
Binghamton, NY 13903